



Included is the
LEGACY FORMAT
of the price book for
your reference only.

This format will be discontinued in
the future pending the feedback and
refinement of the new price book format.



LCN®

Price book 8

Effective April 4, 2020 - Rev. 04/20

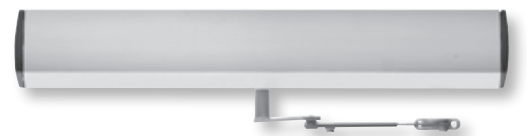
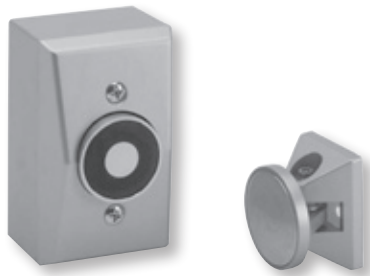

This price list supersedes and cancels all previous price lists. Prices shown are subject to change without notice.

Administrative Offices

Allegion Administrative Office
11819 N. Pennsylvania St.
Carmel, IN 46032
allegion.com/us

Placing orders

You can place orders with Allegion via the fax number or email listed below:

Fax#: 1-800-248-1460
Email: allegion_orders@allegion.com

Customer Care

Our Customer Care Representatives are available for questions or assistance.
You can reach them at **877-671-7011** (Press 1 for Sales Support | Press 2 for Product Support | Press 3 for RSO) or through the email addresses listed below:

Sales Support

support@allegion.com

Technical Product Support

Closers

Closers_TechProdSupport@allegion.com

Request for Quote

Carolinas

(North Carolina, South Carolina, Virginia)
Carolinas.Quotes@allegion.com

Central

(Arkansas, Illinois, Iowa, Kansas, Missouri, Nebraska, Oklahoma)
Central.Quotes@allegion.com

Chicago

(Illinois-Northern, Wisconsin)
Chicago.Quotes@allegion.com

Florida

Florida.Quotes@allegion.com

Great Lakes

(New York, Pennsylvania)
GreatLakes.Quotes@allegion.com

Metro New York

Metro.Quotes@allegion.com

Michigan

Michigan.Quotes@allegion.com

Mid Atlantic North

(New York, Pennsylvania)
Mid.Atlantics.north.quotes@allegion.com

Mid Atlantic South

(Delaware, Maryland, New Jersey)
Mid.Atlantics.south.quotes@allegion.com

Midwest

(Indiana, Kentucky, Ohio, West Virginia)
Midwest.Quotes@allegion.com

Mountain States

(Colorado, Idaho, Montana, Nevada, Utah, Wyoming)
Mtn.States.Quotes@allegion.com

New England

(Connecticut, Main, Massachusetts, New Hampshire, Rhode Island, Vermont)
NewEngland.Quotes@allegion.com

North Central

(Minnesota, North Dakota, South Dakota)
NorthCentral.Quotes@allegion.com

Northern California

NoCal.Quotes@allegion.com

Northwest

(Alaska, Oregon, Washington)
Northwest.Quotes@allegion.com

South

(Alabama, Georgia, Louisiana, Mississippi, Tennessee)
South.Quotes@allegion.com

Southern California

(California-Southern, Hawaii)
SoCal.Quotes@allegion.com

Southwest

(Arizona, New Mexico)
Southwest.Quotes@allegion.com

Texas

Texas.Quotes@allegion.com

TABLE OF CONTENTS

| | | | |
|--------------------------------------|-------|---|--------|
| Contact Information | 2 | Control Box Components..... | 28-29 |
| Table of Contents/How to Order | 3 | Actuator/Sensors Quick Find Guide..... | 30-31 |
| Available Finishes/SRI..... | 4 | Actuators, Sensors and Accessories..... | 32--49 |
| Order Form..... | 5 | Parts & Accessories | 50-63 |
| General Terms..... | 6-9 | Senior Swing Diagram | 64 |
| Door Closer Specialists | 10 | Benchmark Diagram..... | 65 |
| Complete Door Closers | 11-23 | Glossary of Abbreviations..... | 66 |
| Magnets..... | 24 | Wiring Diagrams..... | 67 |
| Specialty Products, Fasteners..... | 25 | Wiring Diagram Request Form..... | 69 |
| Control Boxes..... | 26-27 | LCN Warranty..... | 71 |

HOW TO ORDER CLOSERS, COMPONENTS, PARTS & ACCESSORIES

1. **Identify** the closer series; 1460, 2030, 4040XP, 4210T, 4310ME, 4640, 6030, etc.
2. Determine if any **additional information** is required, such as: handing, finish, spring size, voltage, etc.
3. Order the material using suffix number with the description and include all necessary information.
Examples: 4111 Closer x RH x CUSH x AL or 4040SE Closer x 24v x DKBRZ
4. For additional information on how to order specific closers, please see the 'How to Order' page in each individual closer section of the **LCN General Catalog** or call **LCN Customer Care**.

SPECIAL NOTES

1. All **RAL** custom finishes will be powder coated and metal covers (**list add \$10 for most series, list add \$30 for 1450 and 4050A series**) will be substituted for standard covers for all closers except the 1460 series. 1460 series closers may be custom finished but a **DS** cover (**list add \$30**) must be selected.
2. **LCN** offers more than 180 **RAL** custom finishes. There is a list add of (**\$40**) per closer for an **RAL** finish. Most series require a metal cover (**MC**) (**\$10 add**). **LCN** also offers a Brite Metallic (**MTLPC**) powder coat finish. There is a list add of (**\$60**) per closer for the **MTLPC** finish.
3. **LCN** plated list prices already include -72MC (1460 includes -72DS). Disregard the additional list add for metal cover (**MC**).
4. **LCN** powder finishes exceed **ANSI/BHMA standard A156.4** for corrosion resistance by at least a factor of four. **LCN** powder coat finishes combined with the **LCN Special Rust Inhibitor (SRI)** pre-treatment exceed this standard even further.
5. **Special Rust Inhibitor (SRI)** is a pretreatment that is applied prior to the **LCN** powder coat finish and greatly exceeds **ANSI/BHMA Standard A156.4** for corrosion resistance. **LCN** requires an additional (**list add \$40**) charge per closer, component or part.
6. **LCN** plated finishes exceed **ANSI/BHMA standard A156.4** for corrosion resistance.
7. Optional **TORX** security screw packs can be substituted for standard screw packs on most closers. See '**Add for TORX Screw Pack**' for additional charge. In some cases, not all fasteners can be provided as **TORX**, consult factory for details.
8. **LCN** can mark individual closer boxes with door or opening #'s. Please specify 'itemized' when ordering. Markings (e.g., door number, stock reference numbers) on individual product cartons will be provided with no charge.
9. **Special Template (ST)** pricing is available by contacting **LCN Technical/Product Support or LCN Customer Care**.
10. All closers conform to standards **UL10C** and **UBC 7-2** (1997).
11. If an item or price is not listed in the **LCN April 4, 2020 Price List**, consult factory for availability & pricing.
12. Prices listed in the **LCN April 4, 2020 Price List** are subject to change without notice. The current '**Terms of Sale**' applies.

Powder Coated Finishes

LCN closers can be specified in six standard or over 180 custom powder coated finishes. Powder coating provides superior protection against the effects of weathering and provides a durable, chip resistant finish. For information about custom finishes, plated finishes and a special rust inhibiting (SRI) process, see the LCN General Catalog.

Standard Powder Coated Finishes

See LCN General Catalog, page 5 for exact colors.

- **AL (BHMA 689) - Aluminum**
- **DKBRZ (BHMA 695) - Dark Bronze**
- **BRASS (BHMA 696) - Brass**
- **LTBRZ (BHMA 691) - Light Bronze**
- **STAT (BHMA 690) - Statuary**
- **BLACK (BHMA 693) - Black**

Optional Custom Powder Coated Finishes

- **180 Custom Finishes (contact customer service for availability)**
- **Superior Appearance**
- **Environmentally Friendly Process**
- **Durable and Chip Resistant**
- **Corrosion Resistant**
- **Match Doors, Frames, and Hardware**

Optional SRI

When powder coated closers are installed in high humidity or potentially corrosive installations like swimming pools, water treatment facilities or near large bodies of water, specify LCN SRI Pretreatment. This optional process extends the corrosion protection offered by powder coat finishes.

Optional Plated Finishes

LCN offers 7 plated finishes at additional cost: US 3, US 4, US 10, US 11, US 15, US 26 and US 26D

For a list of available BAA/ARRA compliant products please contact your local RSO or sales representative to see the BAA/ARRA catalog.

Terms and Conditions

Allegion General Terms and Conditions of Sale and Service

1. GENERAL/ACCEPTANCE. (a) This Agreement contains the only terms and conditions by which Company will quote and sell Deliverables to Customer; (b) The terms "purchase order" or "order" for the purposes of this Agreement include the term "request for quotation," as appropriate; (c) This Agreement supersedes all pre-printed or boilerplate terms and conditions set forth in any purchase order issued by Customer; (d) No reference herein to Customer's purchase order will in any way incorporate different or additional terms and conditions, all of which Company hereby expressly objects to; (e) **ANY ACCEPTANCE BY COMPANY OF CUSTOMER'S PURCHASE ORDER IS EXPRESSLY CONDITIONED ON THE CUSTOMER'S ASSENT TO AND ACCEPTANCE OF THE TERMS AND CONDITIONS CONTAINED IN THIS AGREEMENT;** (f) Company reserves the right to decline any order, in whole or in part, for any reason.

2. ORDERS.

a. **Order Processing.** When Customer wishes to place an order for Deliverables, it will deliver to Company a purchase order. All such purchase orders must (i) be in a written format acceptable to Company, (ii) be legible, (iii) include a purchase order number, (iv) include Customer's account number, invoice address, ship to address, shipping method, shipper's letter of instruction for international shipments, part number, pricing, and designated contact information, (v) include, if applicable, any special configuration ID numbers, necessary programming information, special factory instructions, and requested specifications regarding a particular finish, handling, design, backset, or strike, (vi) reference any applicable pricing discounts under an ongoing buying program or based on a written quote from Company, along with the applicable buying program number or quotation number, and (vii) not combine buying program and quoted product on the same order.

b. **Minimum Orders.** In the event the order value does not meet any required minimum net Deliverable value, Company may, at its sole discretion, (i) increase the quantity of items in the order to meet the minimum net Deliverable value requirement; (ii) apply a minimum order charge; (iii) reject the order, or (iv) waive the requirement, provided that the waiver of a requirement for one order shall not constitute a waiver of the requirement for any future orders.

c. **Acceptance of Purchase Orders.** Company will endeavor to (i) acknowledge receipt of each purchase order issued in accordance with this Agreement, and (ii) notify Customer whether Company accepts or rejects the purchase order. If Customer fails to accept or reject a purchase order within a reasonable time period, such failure to respond will be deemed a rejection of the entire order. Orders that combine buying program and quoted product on the same order will be routed back to your local RSO office in order to review subject purchase order.

d. **Changes to Order/ Cancellation of Orders.** Additional terms and conditions regarding order changes and cancellations are available on the Allegion customer website. **WHICH TERMS ARE EXPRESSLY INCORPORATED HEREIN BY REFERENCE.** Unless otherwise provided herein, Customer acknowledges that (i) requesting a Change Order may cause a delay in the scheduled shipment date, a longer lead time or result in a new scheduled shipment date; (ii) Orders may not be changed after 48 hours of Company's order acknowledgment; (iii) After 48 hours of Company's order acknowledgment, all changes to an accepted purchase order will be subject to a Change Order charge of 25% of the net Deliverable value, plus the cost of labor and fabrication or raw material that Company incurred prior to the receipt of the Change Order from Customer, or that may be required due to the Change Order; (iv) the requested change may result in additional charges for labor, fabrication, and raw material, and (v) if Customer cancels an order or portion of an order that includes Deliverables that have been manufactured and prepped for shipping, a 45% restocking fee will apply. Notwithstanding the foregoing, Customer cannot change or cancel credential orders, reader orders, biometrics orders or any non-cataloged, special, custom or nonstandard items once they have been placed. All cancelled orders for a Non Recurring Expense (NRE), credential orders, reader orders, biometrics orders, and/or Custom orders will be subject to a cancellation charge of 100% of the acknowledged price.

e. **Add-ons.** Add-on orders will not be accepted. Additions to orders will be entered as separate stand-alone orders and must qualify for all terms of sale, including discounts, on an individual basis.

f. **Fast-Track Orders.** No changes or cancellations will be accepted on the 24-Hour Fast Track Program. For 3-day Fast Track orders, changes and cancellations may only be requested by Customer within 24 hours of Company's order acknowledgment if the order has not shipped. For 5-Day Fast Track orders, changes and cancellations may only be requested by Customer if the order has not shipped and if the request is made to Company within 48 hours of Company's order acknowledgment. Return Material Authorization (RMA) for Deliverables must be processed through Fast Track Customer Service.

g. **Steelcraft Orders.** For all Steelcraft orders, changes or cancellations are allowed without penalty only if made within 48 hours of Company's order acknowledgment, and provided that the order has not shipped. Some exceptions do apply – please consult the factory. Changes are not allowed on Rapid Program orders after the order has been entered and acknowledged. After 48 hours of Company's order acknowledgment, all changes or cancellations are subject to a charge of 25% of the order. Unless otherwise specified by Company in writing, any changes to orders acknowledged by Company that affect the delivery date will be deemed a new order and will require acknowledgement by Company as provided in this Section. Additional products, features, terms and conditions regarding the Rapid Program are available on the Allegion customer website, **WHICH TERMS ARE EXPRESSLY INCORPORATED HEREIN BY REFERENCE.**

3. PRICES, INVOICES AND PAYMENT.

a. **Prices.** The prices in Company's Price Book are subject to change at any time, without notice to Customer. Company may charge Customer additional amounts if Customer requests special packing, marking, shipment, product modification, or engineering services. Oral prices specified by Company are null and void. Quote numbers must be referenced on Customer's purchase order in order for the Company's quoted pricing to apply. Orders that do not reference a quote number will receive buy program pricing or book net pricing. Quoted prices are for those specific products quoted for a specified job, and are subject to the Price Book in effect at the time Company receives the order.

b. **Taxes.** Prices do not include any present or future federal, state or local property, license, privilege, sales, use, excise, gross receipts or other like taxes or assessments which may result from transactions or any services performed in connection therewith. Any taxes, charges, or duties imposed by any governmental authority on the sale of Deliverables will be paid by Customer, in addition to the selling price specified by Company. Credits for U.S. sales tax applied to invoices will only be granted if valid exemption documentation is provided within 30-days of the invoice date and a case is initiated by customer service. Exemption documentation may be emailed to sales.tax.certificates@allegion.com, this e-mail address cannot be used to request a credit for sales tax charged all such requests must be made with customer service. All certificates sent to the e-mail address must include the following information: (1) Customer account number(s); (2) Customer name; and (3) Allegion brand(s) the certificate should be applied to.

c. **Payment Terms.** Company will deliver to Customer an invoice with each shipment of Deliverables hereunder. Customer will pay all invoiced amounts within 35 days of the invoice date (subject to any early pay discounts that may be offered to Customer by Company in its sole discretion). Customer will make all payments in United States dollars. Past due invoices will be subject to a late payment service charge of 1.5% per month on any overdue unpaid balance, equivalent to 18% per annum, or the maximum rate permitted by law, whichever is less. Customer shall reimburse Company for all costs of collection, including, without limitation, reasonable attorneys' fees, for any overdue amount owed by Customer to Company, and such collection costs shall also be subject to interest charges.

4. QUOTATIONS.

a. **Project Quotations.** Project or new construction quotes are restricted to the specific project quoted for the quantities, finishes, and series of Deliverables referenced on the quote. Company reserves the right to require proof of sale of Company products for any quoted project.

b. **Stock Quotations.** Deliverables fulfilling stock quotations may only be used for the following: i) Stocking of the Customer's shelves for small, quick-turn, discretionary projects, or ii) Sale to a general contractor or installer for new construction. Stock quotations may not be used for any project containing any Company no-substitution, specified products. Deliverables purchased under Stock Quotations cannot be redistributed to other Customer branch locations or re-sold to other resellers or used for aftermarket sales, end-user annual contracts or sold over the counter to any walk in trade.

c. **General.** All quotes are subject to this Agreement, unless otherwise specified by Company, and are subject to change at any time prior to Company's acceptance of a purchase order referencing the applicable quote number. Company, its representatives and employees reserve the right, in their sole discretion and for any reason, to refuse a Customer's request to quote a price other than the standard list price, regardless of whether Company or its representatives or employees have previously quoted discounted prices to the Customer on some or all of its orders. Customer's failure to comply with this Section 4 will be considered a material breach of this Agreement, and will entitle Company to immediately terminate any purchase orders and/or Customer's ability to distribute Company's products.

5. SECURITY INTEREST. Customer grants Company, and Company retains, a purchase money security interest and lien on any and all of Customer's rights, title and interest in each Deliverable sold by Company to Customer, wherever located, until the invoice for the applicable Deliverable(s) is paid in full, including any late charges and costs of collection. Customer authorizes Company to, and will assist Company in, taking all necessary steps to perfect and maintain Company's interest in such Deliverables.

6. CREDIT TERMS. Unless Customer pre-pays all of its purchase orders in advance, its purchase orders will be subject to the credit limit and other terms of credit ("Credit Terms") set forth in Company's credit application, which Credit Terms Customer acknowledges are subject to change by Company at any time. Company reserves the right to request payment in advance of shipment or any order or to request adequate assurances for Customer's payment of an order and may withhold or stop shipment, without any liability to Company, until Customer submits payment or adequate assurance of payment.

7. REALE OF DELIVERABLES. Customer agrees and warrants that it will offer Company products in support of Company-written specifications and will maintain sufficient inventory to adequately support End Users, installers, and/or general contractors' needs. Company may implement an MSRP or a resale pricing programs at any time in its sole discretion. Failure to comply with such program(s) will be considered a material breach of this Agreement, and will entitle Company to immediately terminate any purchase order and/or Customer's ability to distribute Company's products. Customer shall, at its own expense, gain and maintain sufficient knowledge of the industry and products competitive with Deliverables so as to be able to (a) explain in detail to End Users, installers, and/or general contractors the differences between the Deliverables and competing products, (b) ensure that an adequate number of trained, capable and qualified technical personnel with sufficient knowledge of the Deliverables and who have obtained all necessary licenses and permits are available to assist End Users, installers, and/or general contractors, and (c) respond to such End Users, installers, and/or general contractors with respect to the general operation and use of the Deliverables including, but not limited to, (1) acting as a liaison between the End Users, installers and/or general contractors and Company in matters requiring Company participation, (2) providing general product information and configuration support on standard protocols and features, (3) collecting relevant technical problem identification information, and (4) posting and distributing any warranty information concerning the Products in accordance with Company's instructions. Customer is responsible for all service and support resulting from the re-sale of any Deliverable to End-Users, installers and/or general contractors, examples of which may include, but are not limited to, support activities such as installation, initialization, software set-up, training, trouble-shooting, technical support and field service. In the event Customer is unwilling or unable to perform said support activities, Company reserves the right to recover from Customer any and all expenses incurred by Company to resolve the afore-mentioned End-User, installer and/or general contractor issues. Technical product training is recommended for Customer in order to fully service and support Deliverables purchased from Company that are resold to End-Users, installers and/or general contractors.

8. DEFAULT. If Customer is in default of payment or otherwise with respect to any purchase order or other contract with Company, Company shall have the right, in addition to all other legal remedies and without prejudice to any of its right hereunder, to defer further shipments under that or any other purchase order until such default is corrected and to declare all outstanding bills of Customer to be immediately due and payable.

9. INSPECTION AND DELIVERY.

a. **Inspection.** Customer will inspect all Deliverables immediately after receiving them. Customer will be deemed to have accepted the Deliverables unless Customer notifies Company in writing of any nonconformance within 10 days of delivery and provides Company written evidence reasonably documenting that nonconformance. Inspection of Deliverables at Company's facility is not permitted.

b. **Delivery.** Delivery schedules for Deliverables are based upon current production capacities, material or component availability, and inventory, and may be changed by Company as conditions require. Delivery schedules for services are based upon Company's prompt receipt of, and prompt access to, Customer's equipment and all information necessary to complete the services. In no event will any delivery date be construed as falling within the meaning of "time is of the essence." Partial delivery shall be accepted by Customer and paid for at the price and on the terms stated herein. Any partial delivery shall constitute a separate sale, and payment shall be separately made when due. If any part of a delivery hereunder is not delivered by Company in accordance with Customer's purchase order, this Agreement shall not be affected thereby.

10. TITLE & RISK OF LOSS. Unless otherwise specified by Company, (i) where the Customer is located in the United States, all Deliverables will be sold "Uniform Commercial Code, FOB Origin, Company's factory"; and (ii) where the Customer is located outside of the United States, all Products will be sold "Ex-works, Company's factory (Incoterms 2010)." In either instance, title and risk of loss will pass to Customer upon delivery to the carrier at Company's factory, provided, however, as set forth herein, Company shall retain a security interest in the Deliverables until full payment has been made therefore, and Customer agrees, upon request, to do all things and acts necessary to protect Company's interest by adequately insuring the Deliverables against loss or damage from any cause and to have Company named as an additional insured. Customer will promptly provide Company with a copy of the relevant certificate of insurance upon Company's request.

11. SHIPPING.

- a. **Freight Charges.** Company will ship all Deliverables in accordance with Company's freight shipment guidelines, which are set forth on the My Allegion Portal ("Freight Shipping Guidelines"), **WHICH TERMS ARE EXPRESSLY INCORPORATED HEREIN.**
- b. **Rush Charges.** Expedited order options are available as set forth in Company's Freight Shipping Guidelines.
- c. **Packing and Marking.** Company will pack, mark, and ship Deliverables according to its standard procedures for shipment, unless the parties agree, in writing, that Company will comply with any special instructions provided by Customer. Special instructions may result in an increased price.
- d. **International Shipments.** For all international orders, a Shipper's letter of instruction must be submitted in writing with the order. Failure to do so will result in the order being rejected. Complete adherence to this order requirement will be strictly enforced. Company will not be held liable for any charges resulting from delays due to lack of complete required information being supplied.
- e. Once received by the Company, a purchase order cannot be combined with any other order to increase average order size as it relates to Company's Freight Shipping Guidelines. However, for orders placed under Company's FastTrack 24 Hour/5 Day Program (available for Schlage, Von Duprin, LCN and Glynn-Johnson products); ii) FastTrack 24 Hour/3 Day Program (available for Ives products); or ProExpress (available for specific product lines stated in the ProExpress price book for Falcon, Ives, Glynn Johnson, LCN, Schlage and Von Duprin products), the applicable brands or product categories may, subject to certain order requirements identified by Company, be combined on a single order to increase average order size used in Company's Freight Shipping Guidelines.

12. CLAIMS. All claims must be submitted in writing to Company as follows: (i) All claims for prices must be submitted within thirty (30) days from the date of invoice; (ii) All claims regarding Deliverable quantity or incorrect orders must be submitted within ten (10) days from the date of delivery; (iii) All claims for damage to Deliverables (while in the care, custody, and control of Company) must be submitted within thirty (30) days from the date of invoice; (iv) All claims for loss or damage to Deliverables while in the care, custody, and/or control of a carrier will be the responsibility of Customer, unless otherwise agreed by the parties.

13. PRODUCT CHANGES. Company's product policy is one of ongoing update and revision, and accordingly, Company reserves the right to change, without notice, the design of, or the process of manufacturing, the Deliverables covered by this Agreement.

14. PRODUCT USAGE LIMITATION. Customer agrees: (i) not to sell or use a Deliverable in any manner contrary to the manner in which the Deliverable is intended to be used; and/or (ii) not to modify the design of any Deliverable for use with another product without the prior written consent of Company.

15. PRODUCT RETURNS. Unless otherwise agreed by the parties in writing, Deliverables that are correctly furnished by Company per the purchase order may not be returned unless Customer receives written authorization from Company. If returns are authorized by Company, a return merchandise authorization ("RMA") number must be provided by Company. Deliverables identified under such RMA must be returned to Company within 90 days of issuance of the RMA. Such RMA number and any accompanying RMA documents, the original invoice number, and a written explanation for the return must be included with the returned Deliverables in order for Company to inspect and approve a credit for the return. **For warranty returns,** a credit in the amount of the original purchase price will only be issued if, after Company's receipt and inspection of the returned Deliverables, Company confirms, in its sole discretion, the defect is valid and approves the return. **For non-warranty returns/convenience returns,** in the event Company approves such a return, in its sole discretion, the following shall apply: (a) the total amount of Deliverables requested to be returned shall be a minimum of \$250.00; (b) a credit will be made to Customer's account in the amount of the original purchase price less freight and a handling charge of 45% of the net material on the original invoice; and (c) only Deliverables that are new, current, standard, non-obsolete, non-specially manufactured, unused, in their original condition as at the time of sale by Company to Customer, in their original packaging and in Customer's inventory less than 180 days from the date of shipment by the Company, and not ordered as part of a master key solution may be considered by Company for return. Such credit will only be issued if, after Company's receipt and inspection of Deliverables, Company approves the return. The amount of final credit will be determined upon receipt at the factory and following Company's inspection and analysis of the condition of the returned material. Company retains the right to deny credit to anyone for any reason.

16. CONFIDENTIAL INFORMATION.

a. **Non-Use And Non-Disclosure.** Customer shall not use the Confidential Information of the Company except for the purpose of performing its obligations under this Agreement or exercising the rights granted herein (the "Purpose"). Customer shall protect Confidential Information of the Company from disclosure and unauthorized use in the same manner that it protects its own Confidential Information, but in no event shall such standard of care be less than reasonable care. Customer may disclose Confidential Information of the Company only to its employees who require such information for the Purpose and who are subject to confidentiality obligations at least as protective as those set forth herein.

b. **Proprietary Information and Advice.** (a) All designs, data, and specifications provided by Company are proprietary and may not be disclosed or reused by Customer without the prior written consent of Company; (b) Company assumes no obligation or liability for any advice given by Company, the results obtained, or damages incurred as a result of such advice, and all such advice is given and accepted at Customer's risk.

c. **Return.** Upon the termination or expiration of a purchase order or this Agreement or upon the request of the Company, the Customer agrees to end all further use of, to immediately return to the Company the original version of, and to delete or destroy all copies of, any and all Confidential Information of the Company.

17. TRADEMARKS. Except as agreed to by Company in writing, Customer agrees not to (a) use Company's name in any form of publicity; or (b) use, create, register or market, directly or indirectly, in whole or in part, Company's names, logos, brands, or any other trademarks, or names that are now or may hereafter be owned by Company, as part of Customer's corporate or business name, as part of an internet domain name, uniform resource locator (URL), or in any way connected with Customer's business, trade address or other designations. Upon termination of this Agreement or upon the request of company for any reason, any use of Company's trademarks or names will be immediately discontinued.

18. LIMITED WARRANTY.

COMPANY MAKES NO OTHER WARRANTIES EXCEPT THOSE STATED IN COMPANY'S LIMITED WARRANTY IN EFFECT ON THE DATE COMPANY ACCEPTS EACH APPLICABLE PURCHASE ORDER ("LIMITED WARRANTY"). THE LIMITED WARRANTY MAY BE FOUND IN THE APPLICABLE PRICE BOOK AND ON THE ALLEGION CUSTOMER WEBSITE, WHICH TERMS ARE EXPRESSLY INCORPORATED HEREIN BY REFERENCE. COMPANY WILL MAIL CUSTOMER A HARD COPY OF THIS WARRANTY UPON CUSTOMER'S WRITTEN REQUEST. IN THE EVENT THAT CERTAIN DELIVERABLE WARRANTIES ARE NOT FURNISHED BY THE COMPANY TO CUSTOMER, COMPANY WARRANTS ONLY TO CUSTOMER THAT THE DELIVERABLES WILL BE FREE FROM DEFECTS IN MATERIAL AND WORKMANSHIP FOR A PERIOD OF 12 MONTHS FROM THE DATE OF SHIPMENT OF THE DELIVERABLES. COMPANY'S SOLE OBLIGATION UNDER THIS WARRANTY IS LIMITED TO REPAIRING OR REPLACING, AT COMPANY'S OPTION, THE DEFECTIVE DELIVERABLE, PROVIDED WRITTEN NOTICE OF THE DEFECT OR NONCONFORMANCE IS PROVIDED BY CUSTOMER WITHIN 30 DAYS OF DISCOVERY OF THE DEFECT OR NONCONFORMANCE. COMPANY DISCLAIMS ALL OTHER WARRANTIES, EXPRESS OR IMPLIED, WITH RESPECT TO THE DELIVERABLES, INCLUDING BUT NOT LIMITED TO, ANY IMPLIED WARRANTIES OF NON-INFRINGEMENT, MERCHANTABILITY, OR FITNESS FOR A PARTICULAR PURPOSE.

a. **Exclusions.** The provisions of this Limited Warranty do not apply to Deliverables that: (A) are not the proper size for the application; (B) are not installed in accordance with Company's published installation instructions; (C) are installed with improper or incorrect parts and/or are used for purposes for which they are not designed or intended; (D) have been repaired or altered without the Company's prior written consent; (E) have been subjected to misuse, abuse, negligence or accident; (F) have been improperly stored, installed, maintained or operated; (G) have been used in violation of written instructions provided by Company to Customer; (H) have been subjected to improper temperature, humidity, or other environmental conditions, or (I) have been affected by normal wear and tear. In addition, the provisions of this Limited Warranty do not apply to any defects or issues with the design or performance of equipment or products not manufactured by Company, nor does it apply to any code compliance or permit requirements for the assembly, installation, erection or construction of any goods. Company is not responsible for loss or damage resulting from use of Deliverables in conjunction with parts or systems not manufactured by Company. Accessories or products furnished by the Company, but manufactured by others, shall carry whatever warranty the manufacturers have conveyed to the Company and which can be passed to Customer.

b. **Services.** Company warrants that its services will be free from defects in material and workmanship for a period of 12 months from the date of completion of the particular items of service. Company's sole obligation under this service warranty is limited to repair or reperformance, at its option of the service, provided however, if repair or reperformance is either impractical or impossible, the Company will refund to Customer that portion of the price paid to Company for any defective service, provided written notice of the defect or nonconformance is provided by Customer within 30 days of discovery of the nonconformance.

c. **Notification.** Customer agrees to immediately notify Company in writing if any claim is made against Customer for any damages caused by any modules, parts, products, service or other Deliverables which may be the direct result of any defect in the manufacture of such aforementioned products. Customer agrees to cooperate with Company and its counsel in the defense of such claim and Customer agrees not to settle such claim without Company's written consent. If Customer fails to notify Company of such claim or fails to cooperate in such defense as aforesaid, then Company shall be discharged from any obligations under this Section and shall have no further liability to Customer.

d. **Exceptions.** The following costs and expenses are not covered by the provisions of these limited warranties: (i) labor costs for the removal and reinstallation of Deliverables or other manufacturer's products; (ii) shipping and freight expenses required to return Deliverables to Company; (iii) normal maintenance; and (iv) economic losses. In addition, the provisions of this warranty are not applicable to anything other than defects in Company's material (products only) or workmanship.

19. LIMITATION OF REMEDIES.

CUSTOMER'S EXCLUSIVE AND SOLE REMEDY ON ACCOUNT OF, OR IN RESPECT OF, THE FURNISHING OF NON-CONFORMING DELIVERABLES, SHALL BE TO (A) SECURE REPAIR OR REPLACEMENT OF THE PRODUCTS; OR (B) SECURE REPAIR OR RE-PERFORMANCE OF THE SERVICES OR TO OBTAIN A REFUND OF THE PRICE PAID FOR THE DEFECTIVE SERVICE, ALL AT COMPANY'S OPTION. IN NO EVENT WILL THE COMPANY'S MAXIMUM LIABILITY EXCEED THE SELLING PRICE FOR THE DELIVERABLE. THE WARRANTY, OBLIGATIONS AND LIABILITIES OF COMPANY (INCLUDING ITS SUPPLIERS) AND THE RIGHTS AND REMEDIES OF CUSTOMER ARE EXCLUSIVE AND ARE IN LIEU OF AND CUSTOMER HEREBY WAIVES AND RELEASES ALL OTHER WARRANTIES, OBLIGATIONS, REPRESENTATIONS OR LIABILITIES EXPRESS OR IMPLIED ARISING BY LAW, IN CONTRACT, TORT (INCLUDING NEGLIGENCE OR STRICT LIABILITY) OR OTHERWISE, INCLUDING BUT NOT LIMITED TO (I) ANY IMPLIED WARRANTY OF MERCHANTABILITY OR FITNESS FOR A PARTICULAR PURPOSE OR ANY WARRANTY IMPLIED THROUGH COURSE OF PERFORMANCE, COURSE OF DEALING, OR USAGE OF TRADE OR (II) CLAIMS ARISING OUT OF THE NEGLIGENCE OF COMPANY OR COMPANY'S SUPPLIERS OR (III) ANY OTHER CLAIM ARISING OUT OF, CONNECTED WITH, OR RESULTING FROM THE PERFORMANCE OF COMPANY OR FROM THE DESIGN, MANUFACTURE, SALE, REPAIR, LEASE OR USE OF THE DELIVERABLE, OR ANY COMPONENT THEREOF, DELIVERED OR RENDERED HEREUNDER OR OTHERWISE.

20. INDEMNIFICATION AND LIMITATION OF LIABILITY. a. Customer shall indemnify, defend and hold Company, and its officers, directors, employees, customers, Affiliates, suppliers, users and agents, (collectively the "Indemnitees") harmless from and against any and all damages, claims, losses, expenses, costs, obligations, liabilities, including without limiting the generality of the foregoing, liabilities for court costs and attorneys' fees, suffered directly or indirectly by an Indemnitee by reason of, or arising out of any injury, death or loss to any person, or injury to any property (collectively, "Damages"), received or sustained by any person(s) or property, arising out of, occasioned by, attributable or related to i) any breach of any representation or warranty made by Customer, its officers, directors, employees, affiliates, users, agents, representatives or customers to Company or any third party, (ii) any failure by

Terms and Conditions

Customer to perform or fulfill any of its covenants, acts and/or omissions to Company or to any third party, or (iii) any litigation, proceeding or claim by any third party relating in any way to the obligations of Customer and/or the Deliverables sold by Company to Customer hereunder. Customer shall not consummate any settlement of any indemnified claim without the Indemnitees' prior written consent. Customer's obligation to indemnify Indemnitees will continue in full force and effect notwithstanding the termination or expiration of any order under this Agreement. In any claim against an Indemnitee by an employee of Customer or any subcontractor or anyone directly or indirectly employed by any of them or anyone for whose acts they may be liable, the indemnification obligations set forth in this Section shall not be limited in any way by or for Customer or any subcontractor under any applicable worker's compensation act, disability or other employee benefit act, or insurance coverage. This provision shall survive termination of any order or Agreement. **IN NO EVENT WILL COMPANY, ITS OFFICERS, DIRECTORS, EMPLOYEES, CUSTOMERS, AFFILIATES, USERS AND AGENTS, (NOR COMPANY'S SUPPLIERS) BE LIABLE FOR ANY INCIDENTAL, CONSEQUENTIAL, INDIRECT, SPECIAL, OR PUNITIVE DAMAGES OF ANY KIND OR NATURE UNDER ANY CIRCUMSTANCES INCLUDING, BUT NOT LIMITED TO, LOSS OF USE OF THE PRODUCTS, SERVICE INTERRUPTION, LOSS OF PROFITS, LOSS OF REVENUE, LOSS OF INTEREST, LOST GOODWILL, LOSS OF DATA, WORK STOPPAGE, IMPAIRMENT OF OTHER GOODS, LOSS BY REASON OF SHUTDOWN OR NON-OPERATION, INCREASED EXPENSES OF OPERATION, OR CLAIMS OF CUSTOMER'S CUSTOMERS, OR ANY OTHER LOSSES OR DAMAGES ARISING OUT OF ANY LACK OR LOSS OF USE OF THE DELIVERABLES WHETHER BASED ON CONTRACT, WARRANTY, TORT (INCLUDING, BUT NOT LIMITED TO, STRICT LIABILITY OR NEGLIGENCE), PATENT INFRINGEMENT, OR OTHERWISE, EVEN IF ADVISED OF THE POSSIBILITY OF SUCH DAMAGES.**

b) **INTELLECTUAL PROPERTY INDEMNITY.** Company makes no representation or warranty to the Customer that the Deliverables shall not infringe any intellectual property rights including, without limitations, claims arising from patent, copyright, trademark, trade secret, or other intellectual property infringement. Customer agrees to hold Company harmless from and defend the Company against any such claim of intellectual property infringement, including any Damages resulting from that claim, the cost of complying with any preliminary or permanent injunction, and all other costs of defense (including the attorneys' fees and costs), in connection with the foregoing.

c) To the extent that applicable law does not permit any limitations set out in this Agreement, such limitation shall not be applied or invoked. Nothing in this Agreement will be interpreted to disclaim liability of Company or the Indemnitees for gross negligence or willful misconduct. The limitations of remedy and liability herein shall not be interpreted to affect Company's obligations, if any, for claims for (i) property damage, (ii) personal injury, or (iii) wrongful death asserted by persons who are not parties to or beneficiaries of this Agreement. Further, the limitations of remedy and liability herein shall not be interpreted to limit Company's or Customer's right, if permitted by applicable law, to assert a claim for contribution among joint tortfeasors in connection with a claim by a person who is not a party to this Agreement.

21. CERTIFICATIONS. Certification of Deliverables for compliance with UL and ANSI standards are tested and performed by third-party independent laboratories. Any field modification or alteration of certified Deliverables will void certification and Company is not liable to Customer to certify any modified or altered Deliverable.

22. TERM FOR CLAIMS. NO ACTION ARISING OUT OF ANY CLAIMED BREACH OF THIS AGREEMENT BY COMPANY MAY BE BROUGHT BY CUSTOMER MORE THAN ONE (1) YEAR AFTER THE CAUSE OF ACTION HAS ARISEN.

23. CONSUMER PRODUCTS

WITH RESPECT TO "CONSUMER PRODUCTS" AS DEFINED UNDER THE MAGNUSON-MOSS WARRANTY ACT ("MMWA"), THE FOLLOWING STATEMENTS ARE MADE. (A) SOME STATES OR LOCAL LAWS DO NOT ALLOW LIMITATIONS ON HOW LONG AN IMPLIED WARRANTY LASTS, SO THE ABOVE LIMITATION MAY NOT APPLY TO YOU; (B) IF ANY IMPLIED WARRANTY IS PROVIDED UNDER THE MMWA, IT IS LIMITED TO THE DURATION OF THE WARRANTY PROVIDED IN SECTION 18 ABOVE. (C) SOME STATES OR LOCAL LAWS DO NOT ALLOW THE EXCLUSION OR LIMITATION OF INCIDENTAL OR CONSEQUENTIAL DAMAGES, SO THE ABOVE LIMITATION OR EXCLUSION MAY NOT APPLY TO YOU; AND (D) THIS WARRANTY GIVES YOU SPECIFIC LEGAL RIGHTS AND YOU MAY ALSO HAVE OTHER RIGHTS WHICH VARY FROM STATE TO STATE OR LOCATION TO LOCATION.

24. FORCE MAJEURE/EXCUSABLE DELAY. Any delay or failure of Company to perform its obligations hereunder will be excused to the extent that it is caused by an event or occurrence beyond Company's control such as, by way of example and not by way of limitation, acts of God, acts by any governmental authority (whether valid or invalid), governmental laws and regulations not presently in effect, fires, floods, windstorms, explosions, riots, natural disasters, wars, sabotage, accidents, labor problems (including, without limitation, lockouts, strikes, and slowdowns) at Company's facility, its source plant or their suppliers, inability to obtain power, material, labor equipment, or transportation, or court injunction or order. The delivery date will be extended for a time equal to that of the delay and the schedule for Company's performance will be deemed adjusted to that effect.

25. ENTIRE AGREEMENT AND AMENDMENT. This Agreement, together with the attachments, exhibits, webpages, or supplements specifically referenced and incorporated herein, constitute the entire agreement between Company and Customer with respect to the matters contained herein and supersede all previous communications, representations, or agreements, either oral or written between Company and Customer. No agreement or understanding varying or expanding this Agreement will be binding upon either party unless it is in writing and signed by a duly authorized representative of each party hereto.

26. CONFLICTS. In the event of any conflict or inconsistency between the terms of any agreement, or any part of an agreement or the various documents (including, but not limited to, electronic documents) between Company and Customer, unless the parties agree otherwise in writing, the various components of the agreements shall be given the following precedence (in descending order of precedence): a) any master agreement or long term agreement between Company and Customer; b) any specific terms, conditions and/or warranties of the individual products or Deliverables; c) the terms and conditions of this Agreement, and d) any purchase order.

27. UNSATISFACTORY CREDIT/TERMINATION FOR INSOLVENCY OR DEFAULT.

Customer shall furnish Company with statements evidencing Customer's financial condition as Company may, from time to time, reasonably request, and shall notify Company immediately of any and all events that may have a material adverse effect on Customer's business or financial

condition. If Company determines, in its sole discretion, that Customer's financial condition or creditworthiness is inadequate or unsatisfactory, then in addition to Company's other rights, Company may without liability or penalty, take any of the following actions: (i) modify the payment terms for any outstanding and/or future purchases; (ii) cancel any previously accepted orders; (iii) delay any further shipment of Deliverables to Customer; or (iv) any combination of the above.

Company may immediately terminate an order from Customer by giving written notice to Customer in the event of the happening of any of the following or any other comparable event: (i) insolvency of the Customer; (ii) filing of a petition in bankruptcy by or against the Customer; (iii) appointment of a receiver or trustee for the Customer; (iv) execution of an assignment for the benefit of creditors by the Customer, all of which will allow Company to demand reclamation of all affected orders; (v) Customer ceases or threatens to cease to trade; (vi) Company determines that Customer does not meet or no longer meets the credit requirements of Company or Customer's credit account is closed; (vii) any Customer violation of law, specifically including, without limitation, those laws set forth in this Agreement.

In the event of termination in accordance with this section, Company will not be obligated to accept any existing or additional orders from Customer and Company will be released from its obligation to deliver under orders accepted prior to such termination. The rejection or termination of any order by Company will not entitle Customer to any termination or severance compensation, or to any payment in respect to any goodwill established by Customer, or render Company liable for damages on account of the loss of prospective profits, or on account of any loss, expenditure, investment or obligation incurred or made by Customer.

No action taken under this Section 27 by Company (nor any failure of Company to act under this Section 27) will constitute a waiver by Company of any of its rights to enforce Customer's obligations, including the obligation of Customer to make payments as required under this Agreement. Upon termination of any order, all amounts owed by Customer to Company will become immediately due and payable, whether or not otherwise then due or payable.

28. CREDIT RISK ON RESALE OF DELIVERABLES. Customer is responsible for all credit risks with respect to, and for collecting payment for, all Deliverables sold to third parties (including End Users, installers, and/or general contractors) whether or not Customer has made full payment to Company for such Deliverables. The inability of Customer to collect payment for any Deliverable shall not affect Customer's obligation to pay Company for any Deliverable.

29. GOVERNING LAW; VENUE; AND EXPENSES. Any dispute or claim relating to this Agreement shall be governed by and construed according to the laws of the State of Indiana (excluding its conflict of laws principles); and not by the provisions of the 1980 United Nations Convention on the International Sale of Goods. Any disputes or claims shall be instituted and maintained in the courts of the State of Indiana. Customer consents to the exercise of jurisdiction over it by such courts and agrees that Indiana is not an inconvenient forum for any action arising from or relating to this Agreement. Customer agrees to pay for all expenses (including, but not limited to, collection costs, court costs and attorneys' fees) incurred by Company in enforcing the obligations of Customer under this Agreement.

30. RELATIONSHIP OF THE PARTIES. Nothing in this Agreement or any other document creates an employment, partnership, joint venture, or agency relationship between Company and Customer, including that of franchisee/franchisor. No party will have any power or authority to enter into any commitment on behalf of or otherwise bind the any other party on any matter. No employee of Customer will be deemed to be an employee of Company. If any provision of this Agreement is deemed to create a franchise relationship or business opportunity between the Parties, then Company may terminate any purchase order or this Agreement or the Parties shall negotiate in good faith to modify this Agreement so as to effect the original intent of the Parties as closely as possible in a mutually acceptable manner in order that the transactions contemplated hereby are consummated as a reseller agreement and not a franchise or business opportunity agreement.

31. SETOFF. Customer does not have the right to setoff or to back charge against any amounts which become payable to Company under this Agreement or otherwise. Company will not accept responsibility for backcharges for the cost of material or labor by Customer or any third party.

32. ELECTRONIC COMMUNICATIONS AND ELECTRONIC SIGNATURES. Both parties expressly agree to electronic transactions and acknowledge that documents they sign electronically will bind them to the same extent as a paper signature. Customer represents and warrants to Company that only employees authorized to bind Customer legally shall electronically sign any document under this Agreement. Customer shall comply with any method of electronic communication/payment processing specified by Company, including electronic funds transfer, pay-on-receipt processes/systems, order transmission, releases, electronic signature, and electronic communication systems, including, without limitation, the use of electronic data interchange ("EDI") portals. Notwithstanding the foregoing, e-mails, even those containing a signature block of one of Company's representatives, shall not constitute a signed writing.

33. COMPLIANCE WITH APPLICABLE LAWS.

a. General. Company and Customer will comply with all applicable federal, state and municipal laws, regulations, codes, ordinances and orders that pertain to the Deliverables, including but not limited to full compliance with any applicable provisions of The Health Insurance Portability and Accountability Act. Where the Customer is located outside the United States, or where the customer intends to ship the product outside the United States, the Customer shall be responsible for compliance with all U.S. export laws, and for filing all U.S. Electronic Export Information, as applicable.

b. The Customer acknowledges and agrees that: (i) it shall not violate applicable laws and regulations in performing its duties under this Agreement; (ii) it does not and shall not engage in any conduct that shall violate any applicable anti-bribery or anti-corruption laws or regulations; (iii) it (and its owners, officers, directors, employees and agents) shall not pay, offer, promise or authorize the payment of, either directly or indirectly, anything of value (including but not limited to cash, gifts and entertainment) to (a) any government official or employee of any government; (b) any official or employee of any department, agency, or instrumentality of a government; (c) any employee of any corporation or entity owned or controlled by a government; (d) any family member of such officials or employees; (e) any political party, party official, or political candidate; or (f) any other persons, owners, officers, directors, employees and agents of any corporation or entity; to improperly or illegally assist in obtaining or retaining business (including but not limited to any contracts, avoidance of duties or reduction of tariffs, reduction of taxes or

to obtain money owed, or to obtain regulatory approval) or for the purpose of causing, soliciting or inducing the sale and purchase of the Deliverables by any party, and (iv) it has full knowledge of and will comply with the Company's Code of Conduct for Business Partners as set forth on the Allegion customer website. **WHICH IS HEREBY INCORPORATED BY REFERENCE.**

c. The Customer shall indemnify and hold the Company harmless from any claim, demand, expense or cost arising from any breach of this Article.

d. The Customer shall permit the Company to conduct an audit or review of the Customer's financial books and records and business operations at such other times that the Company considers it necessary to confirm compliance with this provision. Such audit may be conducted by representatives of the Company or, at the Company's sole discretion, by a certified public accounting firm selected by the Company. The Customer shall cooperate with any inquiries from the Company's Ethics & Compliance Group.

e. A violation of this provision constitutes a material breach of this Agreement and the Company may terminate any purchase order or this Agreement immediately, with no opportunity to cure, in accordance with Section 27 of this Agreement.

f. Notwithstanding the foregoing provisions of this Section 33, (i) Company is not responsible for obtaining or maintaining any permits for the performance of services or the verification or compliance with any code requirements relative to the performance of services, (ii) to the extent any sale of Deliverables pursuant to this Agreement may require approval of the U.S. Government, Company's obligations under this Agreement are conditioned upon the grant of such approval and upon compliance by Customer with any restrictions imposed by the U.S. Government in connection with such approval, and (iii) in the event the Deliverables are to be used in a nuclear facility, the Customer shall, prior to such use, arrange for insurance or governmental indemnity protecting Company against liability. The Customer hereby releases and agrees to indemnify Company and its suppliers for any nuclear damage including, but not limited to, loss of use, in any manner arising out of the nuclear incident, whether alleged to be due, in whole or in part by Company or its suppliers.

g. **No Inducements.** Each party represents to each other that neither it nor any person acting on its behalf has, in contravention of any applicable law, given or offered to give or will give or offer to give, any sum of money or other material consideration to any person, directly or indirectly, as an inducement to obtain business hereunder or to influence the granting of licenses or other governmental permissions to enter into this Agreement or perform obligations hereunder.

h. **Equal Employment Opportunity.** Company is a U.S. federal contractor that complies with Executive Order 11246, as amended, and applicable regulations in 41 CFR Parts 60-1 through 60-60, 29 U.S.C. § 793 and applicable regulations in 41 CFR § 60-741; and 38 U.S.C. § 4212 and applicable regulations in 41 CFR Part 60-250 and 60-300. **THE FOLLOWING PROVISIONS ARE INCORPORATED HEREIN BY REFERENCE:** Executive Order 11246, as amended by Executive Order 13672, and 41 CFR § 60-4.3(a); Executive Order 11701 and 41 CFR §§ 60-250.5(a), 60-300.5; Executive Order 11758 and 41 CFR § 60-741.5(a); U.S. immigration laws, including the L-1 Visa Reform Act of 2004 and the H-1B Visa Reform Act of 2004; and Executive Order 13496.

i. **Ethical Business Conduct.** Customer shall adopt and comply with Company's Business Partner Code of Conduct which is **EXPRESSLY INCORPORATED HEREIN BY REFERENCE.**

34. REPRESENTATIONS AND WARRANTIES. Customer represents, warrants and covenants to Company that: (a) it has the right, power, and authority to enter into this Agreement and fully perform its obligations hereunder; (b) it has all necessary rights in and to its respective Content and Marks for use within the scope of this Agreement, including the licenses granted herein; and (c) it complies, and at all times shall comply, with all laws, rules, and regulations in effect that are applicable to its performance under this Agreement, including obtaining all such approvals and/or permits as may be required hereunder.

35. NO THIRD-PARTY BENEFICIARY. Each party is entering into this Agreement solely based on the representations contained herein for its own purposes and not for the benefit of any third party.

36. NOTICES AND CHANGE OF ADDRESS. All notices or other communications under this Agreement shall be in writing and delivered in person, or sent by receipted courier, express mail, e-mail, or postage prepaid certified or registered mail, addressed to the party for whom it is intended, at the addresses set forth in this Agreement. Either party may change its address for notice by giving written notice to the other party. Any notice or other communication shall be deemed given no later than the date actually received. Notice by courier, express mail, certified mail, or registered mail shall be deemed given on the date it is officially recorded as delivered and, in the absence of such record of delivery, it shall be rebuttably presumed to have been delivered on the third Business Day after it was deposited. Notices sent by e-mail require tangible confirmation of receipt from addressee.

37. ASSIGNMENT. Customer may not assign this Agreement without the prior written consent of Company. Company may assign its rights and delegate its duties under this Agreement, without the prior consent of Customer, to an Affiliate, or to a third party in the event of a spin-off, merger, business combination, consolidation or sale of all, or substantially all, of its assets or business that are related to this Agreement. The rights and duties in this Agreement shall bind and inure to the benefit of any such assignee.

38. SEVERABILITY. If any provision of this Agreement is held to be invalid, illegal, or unenforceable under any statute, regulation, ordinance, executive order, or other rule of law, that provision will be deemed severed to the extent necessary to comply with such statute, regulation, ordinance, order, or rule. In the event such provision is deemed severed, the parties will negotiate in good faith to arrive at an alternative arrangement approximating the original business objective of the parties. The remaining terms and conditions of this Agreement will remain in effect.

39. NO IMPLIED WAIVER. The failure of either party at any time to require performance by the other party of any provision of this Agreement will in no way affect the right to require such performance at any time thereafter, nor will the waiver of either party of a breach of any provision of this Agreement constitute a waiver of any succeeding breach of the same or any other provision.

40. MISCELLANEOUS. (a) This Agreement does not make either party the agent or legal representative of the other party. Neither party is authorized to create any obligation on behalf of the other party including, but not limited to, the obligation for payment of any service or warranty obligation hereunder; (b) The rights and remedies herein reserved to Company are cumulative and additional to any other rights and remedies provided at law or equity; (c) The official text of this Agreement is in the English language. If this Agreement is translated into another language, the English text will govern any question with respect to interpretation;

(d) The headings in this Agreement are for convenience of reference only and do not affect the meaning of this Agreement in any manner.

DEFINITIONS.

Capitalized terms have the meanings set forth in this Section, or in the Section in which they first appear in this Agreement.

"Agreement" means these Allegion Terms and Conditions of Sale and Service, together with any applicable Country Supplement or Region Supplement provided by Company, and all of the documents referenced herein or therein.

"Affiliate" means any Person that directly or indirectly, through one or more intermediaries, controls, is controlled by, or is under common control with, the Company. The term "control" (including the terms "controlled by" and "under common control with") means the possession, directly or indirectly, of the power to direct or cause the direction of the management and policies of a Person, whether through the ownership of voting securities, by contract or otherwise.

"Business Day" means any day except Saturday, Sunday or any other day on which commercial banks located in the United States are authorized or required by Law to be closed for business.

"Company" means Schlage Lock Company, LLC or any subsidiary or affiliate thereof selling products that are part of the Allegion product portfolio. Schlage Lock Company and/or its subsidiary or affiliates will be severally but not jointly liable under the Agreement.

"Company Marks" refers to the Marks of Company.

"Confidential Information" shall mean any and all information provided by either party to the other party pertaining to the disclosing party's business. Confidential Information shall include, but not be limited to, any bidding lists, formulae for products, manufacturing processes, production techniques, packaging processes, methods, research materials, ideas, marketing plans and related materials, quality standards, test results and data, apparatus, engineering drawings, contract documents, computer software, hardware, or firmware, business activities information such as financial information, reports, projections, books and records, customer and supplier information, and operations, customer and supplier lists and data, specifications, know how, and other Proprietary Information or Trade Secrets (as defined herein) that either party may furnish to the other party. Confidential Information shall not include information that: (a) is or becomes publicly known if such public knowledge or disclosure is not the result of any act or failure to act on the part of the receiving party; (b) is, at the time of disclosure, already known to the Receiving Party without utilizing the Confidential Information; (c) is information disclosed to the Receiving Party by a third party which is not to the Receiving Party's knowledge, after inquiry of the third party, under a duty of confidentiality to the Disclosing Party; or (d) is independently developed by the Receiving Party without the use of Confidential Information. The Receiving Party shall have the burden of proof as to prior knowledge and absence of breach. Confidential Information may be furnished in any tangible or intangible form including, but not limited to, writings, drawings, computer and other electronic media, logic diagrams, component specifications, graphs, prototypes, samples, or verbal communications and regardless of whether such information is marked or designated as "confidential." For the avoidance of doubt, all information, knowledge or data disclosed by Company to Customer, regardless of whether disclosed in written, tangible, oral, visual or other form, including, without limitation, sample products, equipment, software, or other objects or material, provided by Company to Customer, and all information, knowledge or data which was obtained by Customer from visits to Company's facilities, shall be considered "Confidential Information" under this Agreement.

"Content" means all information (including without limitation any text, music, sound, photographs, video, graphics, data or software), in any medium, on a particular Company Web page or Website or in Marketing Materials.

"Customer" means the purchaser of Deliverables from Company.

"Deliverables" means any good or service or both purchased by Customer from Company under these General Terms and Conditions of Sale and Service.

"End Users" means the purchaser that (a) has acquired a Deliverable from Customer for (i) its own and its Affiliate's/Affiliates' internal use and not for resale, remarketing or distribution or (ii) incorporation into its own products and (b) is an individual or entity, other than any federal, state or local agency, office or division.

"IP" means all intellectual property and industrial property rights comprising or relating to/ of the following: (a) Patents; (b) Trademarks; (c) internet domain names, whether or not Trademarks, registered by any authorized private registrar or Governmental Authority, web addresses, web pages, website and URLs; (d) works of authorship, expressions, designs and design registrations, whether or not copyrightable, including copyrights and copyrightable works, software and firmware, application programming interfaces, architecture, files, records, schematics, data, data files, and databases and other specifications and documentation; (e) Trade Secrets; and (f) all other intellectual property and industrial property rights, and all rights, interests and protections that are associated with, equivalent or similar to, or required for the exercise of, any of the foregoing, however arising, in each case whether registered or unregistered and including all registrations and applications for, and renewals or extensions of, such rights or forms of protection pursuant to the Laws of any jurisdiction throughout in any part of the world.

"Marketing Materials" means all marketing brochures, buckslips, pamphlets, emails, text, call scripts or other material, whether in printed format, audio or audiovisual format, or in any other format, that contain any (i) Content relating to the Company Deliverables or (ii) Company Marks.

"Marks" means collectively the domain names, trademarks, trade names, service marks, trade dress, logos, and the like used or provided by either party for use in connection with this Agreement.

"Patents" means all patents (including all reissues, divisionals, provisionals, continuations and continuations-in-part, re-examinations, renewals, substitutions and extensions thereof), patent applications, and other patent rights and any other Governmental Authority-issued indicia of invention ownership (including inventor's certificates, petty patents and patent utility models).

"Person" means a person or entity.

"Price Books" mean Company's current Price Book in effect for the applicable Deliverable being purchased by Customer.

"Trade Secrets" means and includes business or technical information of either party, including processes, formulas, devices, techniques, compilations and other material that a party attempts to maintain in secret and that derive commercial value for such party from not being generally known to the public or readily ascertainable through independent development or reverse engineering.

DOOR CLOSER SPECIALISTS

Since its founding in 1926, LCN has specialized in solving door control problems through the use of high quality, innovative door control products. By adhering to high standards of performance, LCN has earned a leadership role within the industry and is committed to meeting door control challenges of the future. With representatives located throughout the world, LCN provides the products and services necessary to solve your door control problems.

The LCN formula for success



Materials

LCN is committed to providing the best door closers in the world. In addition to the mechanical advantages derived from proven designs, much of the durability of the closer and arm system is related to the materials used in their manufacturing.



Extensive Abuse Test

Why do some hardware professionals claim that LCN stands for "Last Closer Needed?" LCN closers are put through grueling tests in which they exceed industry requirements.



Forged Steel Arms

The closing power and control generated within LCN closers is transferred to the door through forged steel arms. Forged steel arms have greater strength, better appearance and less bulk.

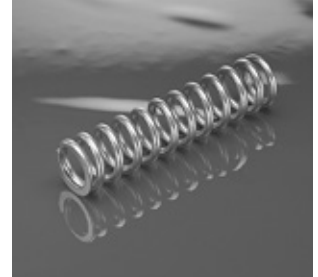

Chrome Silicon

Many closer manufacturers use less expensive oil-tempered springs, but LCN engineers know that such a spring loses up to 20% of its power after a few thousand cycles.



Heat-Treated

LCN steel pinions have larger, stronger teeth and are double heat-treated for the greatest possible strength on the shaft. Heat-treating makes the pinion harder, better able to resist wear after years of service and results in less stress on the cylinder.



Special Templates

When a standard door closer won't do the job, there is only one proven, reliable source for special solutions — LCN. With over 3,000 special templates on file, LCN can provide a door control solution for one-of-a-kind doors such as vault, balanced, over-sized and arch doors.



Hydraulic Fluid

LCN uses a special formula hydraulic fluid with special lubrication properties to keep closer components working smoothly. This unique all-weather hydraulic fluid eliminates the need for seasonal adjustments.



Customer Service

At a time when machines are picking up more and more customer calls, real people are answering the phones at LCN. Every member of our customer service staff is trained and qualified to assist you with orders, closer selection and special applications.

United State Minimum Advertised Pricing Policy (MAP) for LCN

Allegion through its Schlage Lock Company, LLC entity ("Allegion") has determined that certain advertising practices undermine Allegion's trade reputation, brands, and premium image within the target consumer population and discourage Allegion's Resellers (as hereinafter defined) from investing in the Allegion product lines and providing the best possible service and support to consumers. Accordingly, to protect the integrity of the Allegion brands, Allegion has adopted this unilateral Minimum Advertised Price Policy ("MAP Policy"), which applies to all distributors, wholesalers, retailers, and other resellers who are recognized as Authorized Sellers, Authorized Resellers or Authorized Retailers by Allegion (collectively, "Resellers") of Allegion products in the United States of America.

The MAP Policy applies to all products listed on the Allegion MAP Schedule ("Covered Products"). Allegion is solely responsible for establishing the minimum advertised price ("MAP") for each Covered Product and will communicate the MAP for each Covered Product to all Resellers through the Allegion MAP Schedule.

Commercial Product MAP Schedule

- The MAP for the "covered products" for LCN® 4000 and 1460 series offered by Allegion for resale in the United States of America shall be 43% off the list price identified in the most current price book issued by Allegion USA for use in the United States of America.

Manufacturer Suggested Retail Price:

- MSRP will provide guidance to sellers to accurately position our product pricing in the market which represents our brand, quality, and value the products bring to our end customer.
- MSRP will be 23% off list price for LCN 4000's series door closers and LCN 1460's series door closers.

COMPLETE DOOR CLOSERS

PRICE LIST

| CLOSER SERIES | | STANDARD POWDER COAT FINISHES | PLATED FINISHES | | | S H E E T P I N G |  |
|---------------|----------|--|-----------------|-----------------------|-------------------------|---|---|
| SERIES NUMBER | ARM TYPE | AL (689) DKBRZ (695) BRASS (696) LTBRZ (691) STAT (690) BLACK (693) | US26D | US 3 US 4 US 10 | US 11 US 15 US 26 | | |

1250 Series - Surface Mount

| | | | | | |
|------------|---------------|--------------|-----|-----|----|
| 1250 | Rw/PA* | \$215 | N/A | N/A | 8 |
| 1250 | Rw/62A | 230 | N/A | N/A | 7 |
| 1250 | LONG | 210 | N/A | N/A | 7 |
| 1250 | Hw/PA* | 245 | N/A | N/A | 10 |
| 1250 | HLONG | 250 | N/A | N/A | 10 |
| 1250 | EDA | 265 | N/A | N/A | 8 |
| 1250 | HEDA (Handed) | 300 | N/A | N/A | 8 |
| 1250 | CUSH | 300 | N/A | N/A | 9 |
| 1250 | HCUSH | 360 | N/A | N/A | 9 |
| 1250 | SCUSH | 360 | N/A | N/A | 9 |
| 1250 | SHCUSH | 420 | N/A | N/A | 9 |

Add for; Slim Cover (**SLIM**) (\$15), TORX Fasteners (**TORX**) (\$15), Special Rust Inhibitor (**SRI**) (\$40)

*Note - When BAA (Buy American Act) is required for 1250 Rw/PA and Hw/PA in AL or DKBRZ please designate BAA when ordering.

Buy American Act (BAA) (\$30) for 1250 Rw/PA and Hw/PA in AL or DKBRZ.

For parts & accessories, see page 50

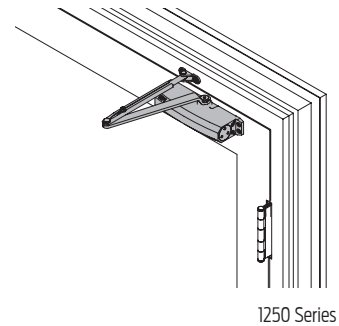

1260 Series - Surface Mount

| | | | | | |
|------------|---------------------|--------------|-----|-----|----|
| 1261 | REG | \$295 | N/A | N/A | 11 |
| 1261 | Rw/PA | 295 | N/A | N/A | 12 |
| 1261 | Rw/62A | 310 | N/A | N/A | 12 |
| 1261 | LONG | 290 | N/A | N/A | 11 |
| 1261 | H | 320 | N/A | N/A | 11 |
| 1261 | Hw/PA | 325 | N/A | N/A | 12 |
| 1261 | HLONG | 330 | N/A | N/A | 11 |
| 1261 | EDA | 345 | N/A | N/A | 13 |
| 1261 | EDA w/62G | 355 | N/A | N/A | 13 |
| 1261 | HEDA (Handed) | 380 | N/A | N/A | 13 |
| 1261 | HEDA w/62G (Handed) | 390 | N/A | N/A | 13 |
| 1261 | CUSH | 380 | N/A | N/A | 12 |
| 1261 | HCUSH | 440 | N/A | N/A | 12 |
| 1261 | SHCUSH | 500 | N/A | N/A | 12 |
| 1261 | SCUSH | 440 | N/A | N/A | 12 |

Add for; Slim Cover (**SLIM**) (\$15), TORX Fasteners (**TORX**) (\$15), Special Rust Inhibitor (**SRI**) (\$40)

For parts & accessories, see page 50.

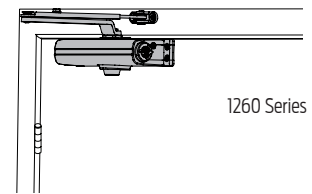

COMPLETE DOOR CLOSERS

PRICE LIST

| CLOSER SERIES | | STANDARD POWDER COAT FINISHES | PLATED FINISHES | | | S H E I P H I G H T |
|---------------|----------|--|-----------------|-----------------------|-------------------------|--|
| SERIES NUMBER | ARM TYPE | AL (689) DKBRZ (695) BRASS (696) LTBRZ (691) STAT (690) BLACK (693) | US26D | US 3 US 4 US 10 | US 11 US 15 US 26 | |



**April
2020**

1450 Series - Surface Mount

| | | | | |
|--------------------|-------|-----|-----|----|
| 1450.....Rw/PA* | \$285 | N/A | N/A | 9 |
| 1450.....Rw/62A | 300 | N/A | N/A | 9 |
| 1450.....LONG | 280 | N/A | N/A | 8 |
| 1450.....Hw/PA* | 315 | N/A | N/A | 11 |
| 1450.....HLONG | 320 | N/A | N/A | 11 |
| 1450.....EDA | 335 | N/A | N/A | 9 |
| 1450.....EDA w/62G | 345 | N/A | N/A | 9 |
| 1450.....HEDA | 370 | N/A | N/A | 9 |
| 1450.....CUSH | 370 | N/A | N/A | 9 |
| 1450.....HCUSH | 430 | N/A | N/A | 10 |
| 1450.....SCUSH | 430 | N/A | N/A | 10 |
| 1450.....SHCUSH | 490 | N/A | N/A | 10 |

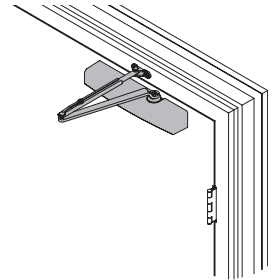

1450 Series

Add for; Delay Action (**DEL**) (\$45), Full Metal Cover (**MC**) (\$30), Full Plastic Cover (**FC**) (\$10), TORX Fasteners (**TORX**) (\$15), Custom Powder Finish (**RAL**) (\$40), Brite Metallic (**MTLPC**) (\$60), Special Rust Inhibitor (**SRI**) (\$40)

*Note - When BAA (Buy American Act) is required for 1450 Rw/PA and Hw/PA in AL or DKBRZ please designate BAA when ordering.
Buy American Act (**BAA**) (\$30) for 1450 Rw/PA and Hw/PA in AL or DKBRZ.

For parts & accessories, see page 50.

1450T Series - Surface Mount

| | | | | |
|--------------------|-------|----|----|----|
| 1450T.....STD | \$360 | NA | NA | 12 |
| 1450T.....H | 385 | NA | NA | 12 |
| 1450T.....BUMPER | 365 | NA | NA | 12 |
| 1450T.....H BUMPER | 395 | NA | NA | 12 |

Add for; Full Metal Cover Cover (**MC**) (\$30), Full Plastic Cover (**FC**) (\$10), TORX Fasteners (**TORX**) (\$15), Special Rust Inhibitor (**SRI**) (\$40), Custom Powder Finish (**RAL**) (\$40), Brite Metallic (**MTLPC**) (\$60)

1460 Series - Surface Mount

| | | | | |
|------------------------------|-------|-------|-------|----|
| 1461.....REG | \$365 | \$735 | \$805 | 9 |
| 1461.....Rw/PA | 370 | 735 | 805 | 11 |
| 1461.....Rw/62A | 385 | 755 | 825 | 11 |
| 1461.....LONG | 365 | 735 | 805 | 9 |
| 1461.....H | 395 | 765 | 835 | 10 |
| 1461.....Hw/PA | 400 | 775 | 845 | 11 |
| 1461.....HLONG | 405 | 775 | 845 | 10 |
| 1461.....HD | 400 | 770 | 840 | 9 |
| 1461.....HD/PA | 405 | 775 | 845 | 11 |
| 1461.....HDw/62A | 420 | 790 | 860 | 11 |
| 1461.....HD/LONG | 405 | 775 | 845 | 10 |
| 1461.....EDA | 420 | 790 | 860 | 12 |
| 1461.....EDA w/62G | 430 | 800 | 870 | 12 |
| 1461.....HEDA (Handed) | 455 | 825 | 895 | 12 |
| 1461.....HEDA w/62G (Handed) | 465 | 835 | 905 | 12 |
| 1461.....CUSH | 455 | 825 | 895 | 11 |
| 1461.....HCUSH | 515 | 885 | 955 | 11 |
| 1461.....SCUSH | 515 | 885 | 955 | 11 |
| 1461.....SHCUSH | 575 | 945 | 1015 | 11 |

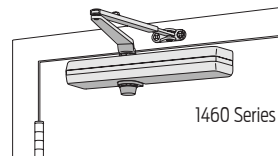

1460 Series

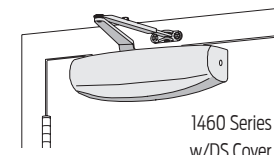

1460 Series
w/DS Cover

Add for; Delay Action (**DEL**) (\$45), Designer Series Cover (**DS**) (\$30), Full Cover (**FC**) (\$10), TORX Fasteners (**TORX**) (\$15), Special Rust Inhibitor (**SRI**) (\$40), Custom Powder Finish (**RAL**) (\$40), Brite Metallic (**MTLPC**) (\$60)

For parts & accessories, see page 51.

1460T Series - Surface Mount

| | | | | |
|---------------------------|-------|-------|-------|----|
| 1460T, 1461T.....STD | \$445 | \$735 | \$815 | 12 |
| 1460T, 1461T.....H | 470 | 760 | 840 | 12 |
| 1460T, 1461T.....BUMPER | 450 | 740 | 820 | 12 |
| 1460T, 1461T.....H BUMPER | 480 | 770 | 850 | 12 |

Add for; Designer Series Cover (**DS**) (\$30), Full Cover (**FC**) (\$10), TORX Fasteners (**TORX**) (\$15), Special Rust Inhibitor (**SRI**) (\$40), Custom Powder Finish (**RAL**) (\$40), Brite Metallic (**MTLPC**) (\$60)

For parts & accessories, see page 51.

Indicates products that have EPD documentation available and meet LEED v4.

COMPLETE DOOR CLOSERS

PRICE LIST

| CLOSER SERIES | | STANDARD POWDER COAT FINISHES | PLATED FINISHES | | | S H E E T P I N G |  |
|---------------|----------|--|-----------------|-----------------------|-------------------------|---|---|
| SERIES NUMBER | ARM TYPE | AL (689) DKBRZ (695) BRASS (696) LTBRZ (691) STAT (690) BLACK (693) | US26D | US 3 US 4 US 10 | US 11 US 15 US 26 | | |

2010 Series - Concealed (Requires Handing)

| | | | | |
|--------------------------------|--------------|---------|---------|----|
| 2011, 2013-2016 STD | \$680 | \$1,190 | \$1,340 | 13 |
| 2011, 2013-2016 H | 705 | 1,215 | 1,365 | 14 |
| 2011, 2013-2016 BUMPER | 685 | 1,195 | 1,345 | 13 |
| 2011, 2013-2016 H BUMPER | 715 | 1,225 | 1,375 | 14 |

Add for; TORX Fasteners (**TORX**) (\$15), Special Rust Inhibitor (**SRI**) (\$40), Custom Powder Finish (**RAL__**) (\$40), Brite Metallic (**MTLPC**)* (\$60)

For parts & accessories, see page 52.

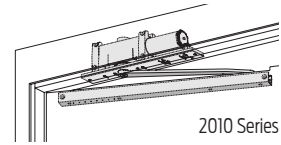

2030 Series - Concealed (Requires Handing)

| | | | | |
|--------------------------|----------------|---------|---------|----|
| 2031-2035 STD | \$1,130 | \$1,640 | \$1,790 | 14 |
| 2031-2035 H | 1,155 | 1,665 | 1,815 | 14 |
| 2031-2035 BUMPER | 1,135 | 1,645 | 1,795 | 14 |
| 2031-2035 H BUMPER | 1,165 | 1,675 | 1,825 | 14 |

Add for; TORX Fasteners (**TORX**) (\$15), Special Rust Inhibitor (**SRI**) (\$40), Custom Powder Finish (**RAL__**) (\$40), Brite Metallic (**MTLPC**)* (\$60)

For parts & accessories, see page 52.

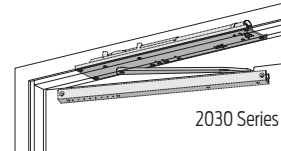

2210 Series - Concealed (Requires Handing)

| | | | | |
|---------------------------|--------------|---------|---------|----|
| 2213-2215 STD | \$945 | \$1,455 | \$1,605 | 17 |
| 2213DPS-2215DPS STD | 1,055 | 1,565 | 1,715 | 17 |

Add for; Advanced Variable Backcheck (**AVB**) (\$25), Special Rust Inhibitor (N/A with DPS) (**SRI**) (\$40), Custom Powder Finish (**RAL__**) (\$40), Brite Metallic (**MTLPC**) (\$60)

For parts & accessories, see page 52.

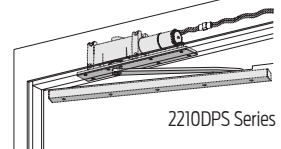

2310ME Series - Concealed (Requires Handing & Voltage)

| | | | | |
|------------------|----------------|---------|---------|----|
| 2314ME STD | \$1,265 | \$1,635 | \$1,725 | 17 |
|------------------|----------------|---------|---------|----|

Add for; Bypass Cylinder (**B80**) or (**B140**) (\$75), TORX Fasteners (**TORX**) (\$15), Custom Powder Finish (**RAL__**)* (\$40), Brite Metallic (**MTLPC**)* (\$60)

For parts & accessories, see page 52.

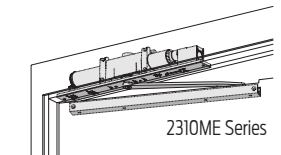

2610 Series - Concealed (Requires Handing)

| | | | | |
|---------------------------|----------------|---------|---------|----|
| 2613-2614 STD | \$2,285 | \$2,795 | \$2,945 | 22 |
| 2613DPS-2614DPS STD | 2,395 | 2,905 | 3,055 | 22 |

Add for; Custom Powder Finish (**RAL__**)* (\$40), Brite Metallic (**MTLPC**)* (\$60)

See pages 20-21 for control boxes and compressors. Also, see pages 26-43 for actuators, tubing, & accessories.

For parts & accessories, see page 53.

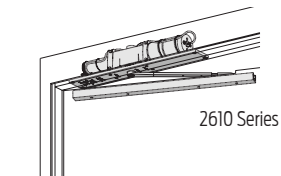

COMPLETE DOOR CLOSERS

PRICE LIST

| CLOSER SERIES | | STANDARD POWDER COAT FINISHES | PLATED FINISHES | | S H E E T P I G H T |  April 2020 |
|---------------|----------|-------------------------------|-----------------|-----|--|--|
| SERIES NUMBER | ARM TYPE | ANCLR ANDKB | N/A | N/A | | |



2810 Series - Concealed (Requires Handing)

| | | | | |
|-----------|--------|----------------|----------------|----|
| 2811..... | STD/CP | \$4,850 | ANCLR or ANDKB | 78 |
| 2811..... | STD/OP | 4,925 | ANCLR or ANDKB | 78 |

Header lengths available 33" to 48" on operators without **POS** or **BKY** (please specify).
 Header lengths available 36" to 48" on operators with **POS** or **BKY** (please specify).
 STD/CP arm has 2 3/4" spindle center, STD/OP arm has 3 3/4" spindle center.
 Add for; Double Door Header (49" to 98" – please specify) (**DD**) (**\$250**),
 Positive Mechanical Stop (STD/CP arm only) (**POS**) (**\$25**), Breakaway Stop (STD/CP arm only) (**BKY**) (**\$100**)
 Manual Prep (requires DD header and STD/OP arm) (49" to 98" - please specify) (**MPDD**) (**\$850**)
 See pages 30-47 for actuators & accessories.
 For parts & accessories, see page 53.



2810 Series



2850 Series - Concealed/Simultaneous Pair

| | | | | |
|-----------|--------|----------------|----------------|-----|
| 2853..... | STD/CP | \$7,900 | ANCLR or ANDKB | 155 |
| 2853..... | STD/OP | 8,050 | ANCLR or ANDKB | 155 |

Header lengths available 52" to 98" on operators without **POS** or **BKY** (please specify).
 Header lengths available 70" to 98" on operators with **POS** or **BKY** (please specify).
 STD/CP arm has 2 3/4" spindle center, STD/OP arm has 3 3/4" spindle center.
 Add for; Positive Mechanical Stop (STD/CP arm only) (**POS**) (**\$50**), Breakaway Stop (STD/CP arm only) (**BKY**) (**\$200**)
 See pages 30-47 for actuators & accessories.
 For parts & accessories, see page 53.

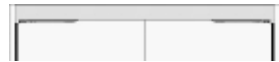

2850 Series



2860 Series - Concealed/Independent Pair

| | | | | |
|-----------|--------|----------------|----------------|-----|
| 2863..... | STD/CP | \$9,600 | ANCLR or ANDKB | 155 |
| 2863..... | STD/OP | 9,750 | ANCLR or ANDKB | 155 |

Header lengths available 65" to 98" on operators without **POS** or **BKY** (please specify).
 Header lengths available 70" to 98" on operators with **POS** or **BKY** (please specify).
 STD/CP arm has 2 3/4" spindle center, STD/OP arm has 3 3/4" spindle center.
 Add for; Positive Mechanical Stop (STD/CP arm only) (**POS**) (**\$50**), Breakaway Stop (STD/CP arm only) (**BKY**) (**\$200**)
 See pages 30-47 for actuators & accessories.
 For parts & accessories, see page 53.

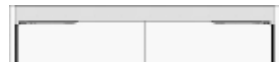

2860 Series

| CLOSER SERIES | | STANDARD POWDER COAT FINISHES | PLATED FINISHES | | | S H E E T P I C H I N G |
|---------------|----------|--|-----------------|-----------------------|-------------------------|--|
| SERIES NUMBER | ARM TYPE | AL (689) DKBRZ (695) BRASS (696) LTBRZ (691) STAT (690) BLACK (693) | US26D | US 3 US 4 US 10 | US 11 US 15 US 26 | |



3030 Series - Concealed (Requires Handing)

| | | | | |
|--------------------|--------------|-------|-------|---|
| 3031-3034..... REG | \$470 | \$690 | \$720 | 6 |
| 3031-3034..... H | 470 | 690 | 720 | 6 |

Add for; TORX Fasteners (**TORX**) (\$15), Special Rust Inhibitor (**SRI**) (\$40), Custom Powder Finish (**RAL**___)* (\$40), Brite Metallic (**MTLPC**)* (\$60)
For parts & accessories, see page 54.

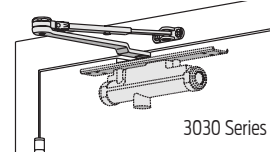

3130 Series - Concealed (Requires Handing)

| | | | | |
|-------------------------|--------------|-------|-------|---|
| 3131-3133..... STD | \$570 | \$790 | \$820 | 8 |
| 3131-3133..... H | 595 | 815 | 845 | 8 |
| 3131-3133..... BUMPER | 575 | 795 | 825 | 8 |
| 3131-3133..... H BUMPER | 605 | 825 | 855 | 8 |

Add for; TORX Fasteners (**TORX**) (\$15), Special Rust Inhibitor (**SRI**) (\$40), Custom Powder Finish (**RAL**___)* (\$40), Brite Metallic (**MTLPC**)* (\$60)
For parts & accessories, see page 54.

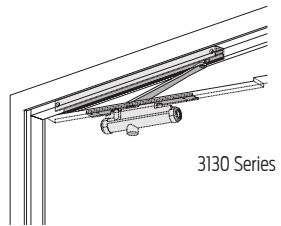

3130SE Series - Concealed (Requires Handing & Voltage)

| | | | | |
|--------------------------|--------------|---------|---------|---|
| 3133SE-3134SE STD | \$915 | \$1,135 | \$1,165 | 8 |
| 3133SE-3134SE LONG | 925 | 1,145 | 1,175 | 8 |

Add for; TORX Fasteners (**TORX**) (\$15), Custom Powder Finish (**RAL**___)* (\$40), Brite Metallic (**MTLPC**)* (\$60)
For parts & accessories, see page 54.

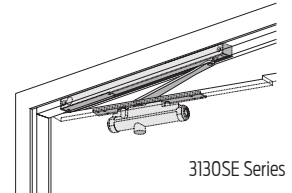

4000T Series - Wall Pocket (SEM7800 Series Available Separately)

| | | | | |
|-----------------------|--------------|-------|---------|----|
| 4003T-4004T STD | \$565 | \$975 | \$1,055 | 15 |
|-----------------------|--------------|-------|---------|----|

Add for; Metal Cover (**MC**) (\$15), TORX Fasteners (**TORX**) (\$15), Special Rust Inhibitor (**SRI**) (\$40), Custom Powder Finish (**RAL**___)* (\$40), Brite Metallic (**MTLPC**)* (\$60)
For parts & accessories, see page 54.

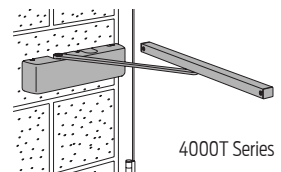

4010 Series - Surface Mount (Requires Handing)

| | | | | |
|------------------------|--------------|-------|-------|----|
| 4011 or 4016 REG | \$495 | \$905 | \$985 | 11 |
| 4011 or 4016 H | 550 | 960 | 1,040 | 12 |
| 4011 or 4016 FL | 645 | NA | NA | 15 |

Add for; Delay Action (**DEL**) (\$45) (4011 only), Telephone Cylinder (**TEL**) (\$45), Metal Cover (**MC**) (\$15), TORX Fasteners (**TORX**) (\$15), Special Rust Inhibitor (**SRI**) (\$40), Custom Powder Finish (**RAL**___)* (\$40), Brite Metallic (**MTLPC**)* (\$60)

Note - 4010 Series is available as 4011 (Adjustable 1-5) or 4016 (Size 6 Only - Not ADA Compliant).
For parts & accessories, see page 54.

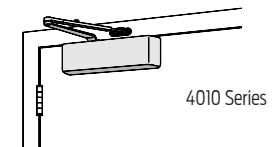

4010T Series - Surface Mount (Requires Handing)

| | | | | |
|--------------------------------------|--------------|-------|---------|----|
| 4011T, 4013T-4014T STD | \$565 | \$975 | \$1,055 | 16 |
| 4011T, 4013T-4014T H | 590 | 1000 | 1080 | 16 |
| 4011T, 4013T-4014T BUMPER | 570 | 980 | 1060 | 16 |
| 4011T, 4013T-4014T H BUMPER | 600 | 1010 | 1090 | 16 |
| 4011T, 4013T-4014T DE | 600 | 1010 | 1090 | 16 |
| 4011T, 4013T-4014T DE HO | 625 | 1035 | 1115 | 16 |
| 4011T, 4013T-4014T DE BUMPER | 605 | 1015 | 1095 | 16 |
| 4011T, 4013T-4014T DE H BUMPER | 635 | 1045 | 1125 | 16 |

Add for; Metal Cover (**MC**) (\$15), TORX Fasteners (**TORX**) (\$15), Special Rust Inhibitor (**SRI**) (\$40), Custom Powder Finish (**RAL**___)* (\$40), Brite Metallic (**MTLPC**)* (\$60)

For parts & accessories, see page 55.

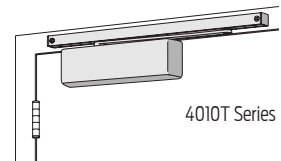

Indicates products that have EPD documentation available and meet LEED v4.

COMPLETE DOOR CLOSERS

PRICE LIST



| CLOSER SERIES | | STANDARD POWDER COAT FINISHES | PLATED FINISHES | | | S H E E T P I G H T |
|---------------|----------|--|-----------------|-----------------------|-------------------------|--|
| SERIES NUMBER | ARM TYPE | AL (689) DKBRZ (695) BRASS (696) LTBRZ (691) STAT (690) BLACK (693) | US26D | US 3 US 4 US 10 | US 11 US 15 US 26 | |



4020 Series - Surface Mount (Requires Handing)

| | | | | |
|------------------------|--------------|-------|-------|----|
| 4021 or 4026..... REG | \$495 | \$905 | \$985 | 11 |
| 4021 or 4026..... LONG | 500 | 910 | 990 | 11 |
| 4021 or 4026..... H | 550 | 960 | 1,040 | 12 |
| 4021 or 4026..... FL | 645 | NA | NA | 12 |

Add for; Delay Action (**DEL**) (\$45) (4021 only), Telephone Cylinder (**TEL**) (\$45), Metal Cover (**MC**) (\$15), TORX Fasteners (**TORX**) (\$15), Special Rust Inhibitor (**SRI**) (\$40), Custom Powder Finish (**RAL**___)* (\$40), Brite Metallic (**MTLPC**)* (\$60)

Note - 4020 Series is available as 4021 (Adjustable 1-5) or 4026 (Size 6 Only - Not ADA Compliant).
For parts & accessories, see page 55.

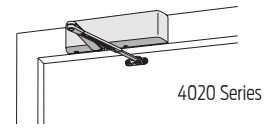

4020T Series - Surface Mount (Requires Handing)

| | | | | |
|-----------------------------------|--------------|-------|---------|----|
| 4021T, 4023T-4024T STD | \$565 | \$975 | \$1,055 | 15 |
| 4021T, 4023T-4024T H | 590 | 1,000 | 1,080 | 16 |
| 4021T, 4023T-4024T BUMPER | 570 | 980 | 1,060 | 15 |
| 4021T, 4023T-4024T H BUMPER | 600 | 1,010 | 1,090 | 16 |

Add for; Metal Cover (**MC**) (\$15), TORX Fasteners (**TORX**) (\$15), Special Rust Inhibitor (**SRI**) (\$40), Custom Powder Finish (**RAL**___)* (\$40), Brite Metallic (**MTLPC**)* (\$60)

For parts & accessories, see page 55.

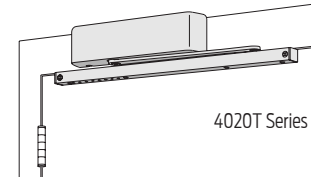

4030 Series - Surface Mount

| | | | | |
|------------------------|--------------|-------|-------|---|
| 4031..... REG | \$460 | \$855 | \$935 | 8 |
| 4031.....Rw/PA | 460 | 855 | 935 | 9 |
| 4031.....Rw/62A | 485 | 880 | 960 | 8 |
| 4031.....LD | 435 | 830 | 910 | 8 |
| 4031.....LD/PA | 450 | 845 | 925 | 8 |
| 4031.....LD/62A | 465 | 860 | 940 | 8 |
| 4031.....LONG | 465 | 860 | 940 | 8 |
| 4031.....H | 515 | 910 | 990 | 8 |
| 4031.....Hw/PA | 525 | 920 | 1000 | 9 |
| 4031.....HLONG | 525 | 920 | 1000 | 8 |
| 4031.....EDA | 500 | 895 | 975 | 9 |
| 4031.....HEDA (Handed) | 540 | 935 | 1,015 | 9 |
| 4031.....CUSH | 530 | 925 | 1,005 | 9 |
| 4031.....HCUSH | 600 | 995 | 1,075 | 9 |
| 4031.....SCUSH | 605 | 1000 | 1,080 | 9 |
| 4031.....SHCUSH | 655 | 1,050 | 1,130 | 9 |

Add for; Special Rust Inhibitor (**SRI**) (\$40), Custom Powder Finish (**RAL**___)* (\$40), Brite Metallic (**MTLPC**)* (\$60)

For parts & accessories, see page 56.

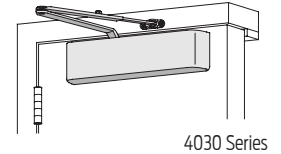

4030T Series - Surface Mount

| | | | | |
|---------------|--------------|-------|---------|---|
| 4031T.....STD | \$530 | \$925 | \$1,005 | 9 |
| 4031T.....H | 555 | 950 | 1030 | 9 |

Add for; Special Rust Inhibitor (**SRI**) (\$40), Custom Powder Finish (**RAL**___)* (\$40), Brite Metallic (**MTLPC**)* (\$60)

For parts & accessories, see page 56.

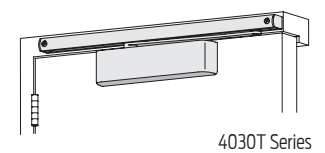

Indicates products that have EPD documentation available and meet LEED v4.

COMPLETE DOOR CLOSERS

PRICE LIST

| CLOSER SERIES | | STANDARD POWDER COAT FINISHES | PLATED FINISHES | | | S H E E T P I N G |  |
|---------------|----------|--|-----------------|-----------------------|-------------------------|---|---|
| SERIES NUMBER | ARM TYPE | AL (689) DKBRZ (695) BRASS (696) LTBRZ (691) STAT (690) BLACK (693) | US26D | US 3 US 4 US 10 | US 11 US 15 US 26 | | |



4040XP Series - Surface Mount

| | | | | | |
|--------|---------------------|-------|-------|---------|----|
| 4040XP | REG | \$525 | \$935 | \$1,015 | 13 |
| 4040XP | Rw/PA | 525 | 935 | 1,015 | 13 |
| 4040XP | LONG | 530 | 940 | 1,020 | 14 |
| 4040XP | XLONG | 565 | 975 | 1,055 | 14 |
| 4040XP | Rw/62A | 550 | 960 | 1,040 | 12 |
| 4040XP | H | 580 | 990 | 1,070 | 13 |
| 4040XP | Hw/PA | 590 | 1,000 | 1,080 | 12 |
| 4040XP | HLONG | 590 | 1,000 | 1,080 | 12 |
| 4040XP | EDA | 565 | 975 | 1,055 | 14 |
| 4040XP | EDA w/62G | 570 | 980 | 1,060 | 13 |
| 4040XP | HEDA (Handed) | 605 | 1,015 | 1,095 | 14 |
| 4040XP | HEDA w/62G (Handed) | 615 | 1,025 | 1,105 | 13 |
| 4040XP | CUSH | 595 | 1,005 | 1,085 | 14 |
| 4040XP | HCUSH | 665 | 1,075 | 1,155 | 14 |
| 4040XP | SCUSH | 670 | 1,080 | 1,160 | 15 |
| 4040XP | SHCUSH | 720 | 1,130 | 1,210 | 15 |

Add for; Delay Action (**DEL**) (\$45), Metal Cover (Handed) (**MC**) (\$15), TORX Fasteners (**TORX**) (\$15), Special Rust Inhibitor (**SRI**) (\$40), Custom Powder Finish (RAL___)* (\$40), Brite Metallic (**MTLPC**)* (\$60)
For parts & accessories, see page 56.

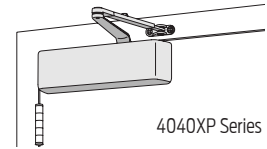

4040XPT Series - Surface Mount

| | | | | | |
|---------|----------------------|-------|---------|---------|----|
| 4040XPT | STD | \$595 | \$1,005 | \$1,085 | 15 |
| 4040XPT | H | 620 | 1030 | 1110 | 16 |
| 4040XPT | BUMPER | 600 | 1,010 | 1090 | 15 |
| 4040XPT | H BUMPER | 630 | 1040 | 1120 | 16 |
| 4040XPT | DE (Handed) | 645 | 1055 | 1,135 | 16 |
| 4040XPT | DE H (Handed) | 670 | 1,080 | 1,160 | 16 |
| 4040XPT | DE BUMPER (Handed) | 650 | 1060 | 1,140 | 16 |
| 4040XPT | DE H BUMPER (Handed) | 680 | 1090 | 1,170 | 16 |

Add for; Metal Cover (Handed) (**MC**) (\$15), TORX Fasteners (**TORX**) (\$15), Special Rust Inhibitor (**SRI**) (\$40), Custom Powder Finish (RAL___)* (\$40), Brite Metallic (**MTLPC**)* (\$60)
For parts & accessories, see page 57.

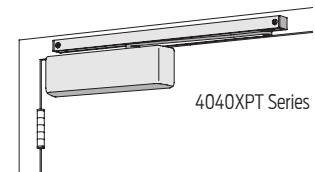

4040SE Series - Surface Mount (Requires Voltage)

| | | | | | |
|--------|-------------|-------|---------|---------|----|
| 4040SE | STD | \$925 | \$1,335 | \$1,415 | 12 |
| 4040SE | LONG | 925 | 1,335 | 1,415 | 12 |
| 4040SE | DE (Handed) | 975 | 1,385 | 1,465 | 12 |

Add for; Metal Cover (Handed) (**MC**) (\$15), TORX Fasteners (**TORX**) (\$15), Custom Powder Finish (RAL___)* (\$40), Brite Metallic (**MTLPC**)* (\$60)
For parts & accessories, see page 57.

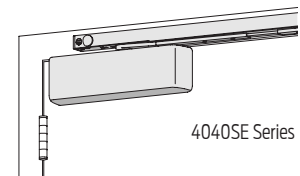

4040SEH Series - Surface Mount Arm & Track Only (Requires Voltage) (Closer Available Separately)

| | | | | | |
|---------|--------------------|-------|-------|-------|---|
| 4040SEH | 4040SEH-3038 w/Arm | \$585 | \$805 | \$835 | 8 |
|---------|--------------------|-------|-------|-------|---|

Add for; TORX Fasteners (**TORX**) (\$15)
Note - Includes 4040SEH Track & 4040SEH Arm Only.
For parts & accessories, see page 57.

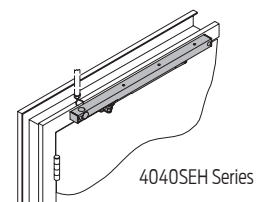

Indicates products that have EPD documentation available and meet LEED v4.

COMPLETE DOOR CLOSERS

PRICE LIST

| CLOSER SERIES | | STANDARD POWDER COAT FINISHES | PLATED FINISHES | | | S H E E T P I G H T |  |
|---------------|----------|--|-----------------|-----------------------|-------------------------|--|---|
| SERIES NUMBER | ARM TYPE | AL (689) DKBRZ (695) BRASS (696) LTBRZ (691) STAT (690) BLACK (693) | US26D | US 3 US 4 US 10 | US 11 US 15 US 26 | | |

4050A Series - Surface Mount

| | | | | | |
|-------|---------------------|-------|-----|-----|----|
| 4050A | Rw/PA | \$445 | N/A | N/A | 13 |
| 4050A | LONG | 450 | N/A | N/A | 14 |
| 4050A | Rw/62A | 470 | N/A | N/A | 13 |
| 4050A | Hw/PA | 510 | N/A | N/A | 12 |
| 4050A | HLONG | 510 | N/A | N/A | 12 |
| 4050A | EDA | 485 | N/A | N/A | 14 |
| 4050A | EDA w/62G | 490 | N/A | N/A | 13 |
| 4050A | HEDA (handed) | 525 | N/A | N/A | 14 |
| 4050A | HEDA w/62G (handed) | 535 | N/A | N/A | 13 |
| 4050A | CUSH | 515 | N/A | N/A | 14 |
| 4050A | HCUSH | 585 | N/A | N/A | 14 |
| 4050A | SCUSH | 590 | N/A | N/A | 15 |
| 4050A | SHCUSH | 640 | N/A | N/A | 15 |

Add for; Delay Action (**DEL**) (\$45), Metal Cover (**MC**) (\$15), TORX Fasteners (**TORX**) (\$15), Custom Powder Finish (**RAL**___) (\$40), Brite Metallic (**MTLPC**) (\$60), Special Rust Inhibitor (**SRI**) (\$40).
For parts & accessories, see page 57.

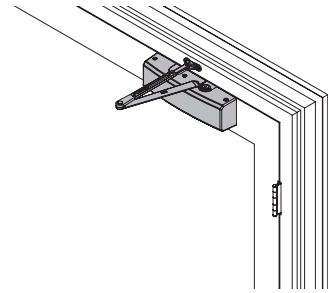

4050 Series

4050AT Series - Surface Mount

| | | | | | |
|--------|----------------------|-----|-----|-----|----|
| 4050AT | STD | 515 | N/A | N/A | 15 |
| 4050AT | H | 540 | N/A | N/A | 16 |
| 4050AT | BUMPER | 520 | N/A | N/A | 15 |
| 4050AT | H BUMPER | 550 | N/A | N/A | 16 |
| 4050AT | DE (Handed) | 550 | N/A | N/A | 16 |
| 4050AT | DE H (Handed) | 575 | N/A | N/A | 16 |
| 4050AT | DE BUMPER (Handed) | 555 | N/A | N/A | 16 |
| 4050AT | DE H BUMPER (Handed) | 585 | N/A | N/A | 16 |

Add for; Metal Cover (**MC**) (\$15), TORX Fasteners (**TORX**) (\$15), Special Rust Inhibitor (**SRI**) (\$40), Custom Powder Finish (**RAL**___) (\$40), Brite Metallic (**MTLPC**) (\$60).
For parts & accessories, see page 58.

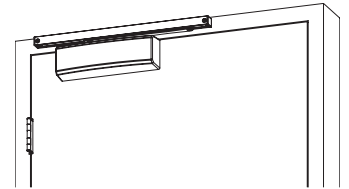

4050AT Series

4110 Series - Surface Mount (Requires Handing)

| | | | | | |
|--------------|------------|-------|-------|---------|----|
| 4111 or 4116 | EDA | \$510 | \$920 | \$1,000 | 13 |
| 4111 or 4116 | EDA w/62G | 515 | 925 | 1,005 | 13 |
| 4111 or 4116 | HEDA | 550 | 960 | 1,040 | 13 |
| 4111 or 4116 | HEDA w/62G | 560 | 970 | 1,050 | 13 |
| 4111 or 4116 | FL | 620 | NA | NA | 15 |
| 4111 or 4116 | CUSH | 540 | 950 | 1,030 | 13 |
| 4111 | HCUSH | 610 | 1,020 | 1,100 | 14 |
| 4111 or 4116 | SCUSH | 615 | 1,025 | 1,105 | 15 |
| 4111 | SHCUSH | 665 | 1,075 | 1,155 | 15 |

Add for; Delay Action (**DEL**) (\$45) (4111 only), Advanced Variable Backcheck (**AVB**) (\$25), Telephone Cylinder (**TEL**) (\$45), Metal Cover (**MC**) (\$15), TORX Fasteners (**TORX**) (\$15), Special Rust Inhibitor (**SRI**) (\$40), Custom Powder Finish (**RAL**___)* (\$40), Brite Metallic (**MTLPC**)* (\$60)
Note - 4110 Series is available as 4111 (Adjustable 1-5) or 4116 (Size 6 Only - Not ADA Compliant).
For parts & accessories, see page 58.

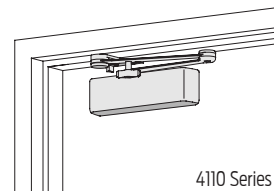

4110 Series

4110T Series - Surface Mount (Requires Handing)

| | | | | | |
|--------------------|----------|-------|-------|---------|----|
| 4111T, 4113T-4114T | STD | \$540 | \$950 | \$1,030 | 15 |
| 4111T, 4113T-4114T | H | 565 | 975 | 1,055 | 16 |
| 4111T, 4113T-4114T | BUMPER | 545 | 955 | 1,035 | 15 |
| 4111T, 4113T-4114T | H BUMPER | 575 | 985 | 1,065 | 16 |

Add for; Metal Cover (**MC**) (\$15), TORX Fasteners (**TORX**) (\$15), Special Rust Inhibitor (**SRI**) (\$40), Custom Powder Finish (**RAL**___)* (\$40), Brite Metallic (**MTLPC**)* (\$60)
For parts & accessories, see page 58.

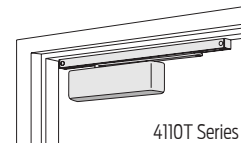

4110T Series

COMPLETE DOOR CLOSERS

PRICE LIST

| CLOSER SERIES | | STANDARD POWDER COAT FINISHES | PLATED FINISHES | | | S H E E T P I N G |  |
|---------------|----------|--|-----------------|-----------------------|-------------------------|---|---|
| SERIES NUMBER | ARM TYPE | AL (689) DKBRZ (695) BRASS (696) LTBRZ (691) STAT (690) BLACK (693) | US26D | US 3 US 4 US 10 | US 11 US 15 US 26 | | |



4210 Series - Surface Mount (Requires Handing)

| | | | | |
|------------------------|--------------|-------|---------|----|
| 4211 or 4216EDA | \$570 | \$965 | \$1,045 | 14 |
| 4211 or 4216CUSH | 600 | 995 | 1,075 | 14 |
| 4211.....HCUSH | 670 | 1,065 | 1,145 | 15 |

Add for; Delay Action (**DEL**) (**\$45**) (4211 only), Advanced Variable Backcheck (**AVB**) (**\$25**), Special Rust Inhibitor (**SRI**) (**\$40**), Custom Powder Finish (**RAL__**)* (**\$40**), Brite Metallic (**MTLPC**)* (**\$60**)
 Note - 4210 Series is available as 4211 (Adjustable 1-5) or 4216 (Size 6 Only - Not ADA Compliant).
 For parts & accessories, see page 59.

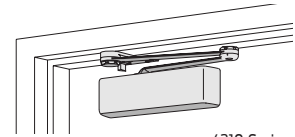

4210 Series



4210T Series - Surface Mount (Requires Handing)

| | | | | |
|----------------------------|--------------|---------|---------|----|
| 4211T, 4213T-4214T.....STD | \$680 | \$1,075 | \$1,155 | 15 |
|----------------------------|--------------|---------|---------|----|

Add for; Advanced Variable Backcheck (**AVB**) (**\$25**), Special Rust Inhibitor (**SRI**) (**\$40**), Custom Powder Finish (**RAL__**)* (**\$40**), Brite Metallic (**MTLPC**)* (**\$60**)
 For parts & accessories, see page 59.

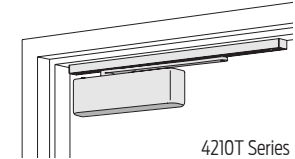

4210T Series



4310HSA Series - Surface Mount (Requires Handing & Voltage)

| | | | | |
|-----------------|----------------|---------|---------|----|
| 4311HSA.....STD | \$1,380 | \$1,775 | \$2,030 | 22 |
| 4311HSA.....DE | 1,430 | 1,825 | 2,080 | 22 |

Add for; Custom Powder Finish (**RAL__**)* (**\$40**), Brite Metallic (**MTLPC**)* (**\$60**)
 For parts & accessories, see page 59.



4310HSA Series



4310ME Series - Surface Mount (Requires Handing & Voltage)

| | | | | |
|---------------|----------------|---------|---------|----|
| 4314ME.....SF | \$1,295 | \$1,690 | \$1,945 | 17 |
| 4314ME.....DE | 1,345 | 1,740 | 1,995 | 17 |

Add for; Bypass Cylinder (**B80**) or (**B140**) (**\$85**), TORX Fasteners (**TORX**) (**\$15**), Custom Powder Finish (**RAL__**)* (**\$40**), Brite Metallic (**MTLPC**)* (**\$60**)
 For parts & accessories, see page 59.

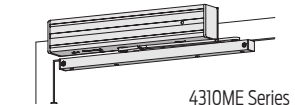

4310ME Series

Indicates products that have EPD documentation available and meet LEED v4.

COMPLETE DOOR CLOSERS

PRICE LIST

| CLOSER SERIES | | STANDARD POWDER COAT FINISHES | PLATED FINISHES | | | S H E E T P I N G |  |
|---------------|----------|--|-----------------|-----------------------|-------------------------|---|---|
| SERIES NUMBER | ARM TYPE | AL (689) DKBRZ (695) BRASS (696) LTBRZ (691) STAT (690) BLACK (693) | US26D | US 3 US 4 US 10 | US 11 US 15 US 26 | | |



4410HSA Series - Surface Mount (Requires Handing & Voltage)

| | | | | | |
|---------|------|---------|---------|---------|----|
| 4412HSA | REG | \$1,310 | \$1,705 | \$1,960 | 22 |
| 4412HSA | LONG | 1,315 | 1,710 | 1,965 | 22 |

Add for; Custom Powder Finish (RAL__)* (\$40), Brite Metallic (MTLPC)* (\$60)
Closer price includes 4410HSA-18 for regular mount or 4410HSA-18G (please specify) plate for flush mount application.)
For parts & accessories, see page 60.

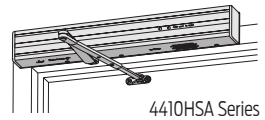

4410ME Series - Surface Mount (Requires Handing & Voltage)

| | | | | | |
|--------|------|---------|---------|-------|----|
| 4414ME | REG | \$1,225 | \$1,620 | 1875 | 17 |
| 4414ME | LONG | 1230 | 1,625 | 1,880 | 17 |

Add for; Bypass Cylinder (B80) or (B140) (\$85), TORX Fasteners (TORX) (\$15), Custom Powder Finish (RAL__)* (\$40), Brite Metallic (MTLPC)* (\$60)
Closer price includes 4410ME-18 for regular mount or 4410ME-18G (please specify) plate for flush mount application.
For parts & accessories, see page 60.

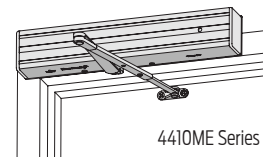

4510 Series - Surface Mount (Requires Handing)

| | | | | | |
|--------------|-----|-------|-------|---------|----|
| 4511 or 4516 | EDA | \$570 | \$965 | \$1,045 | 14 |
|--------------|-----|-------|-------|---------|----|

Add for; Delay Action (\$45) (4511 only), Advanced Variable Backcheck (AVB) (\$25), Special Rust Inhibitor (SRI) (\$40), Custom Powder Finish (RAL__)* (\$40), Brite Metallic (MTLPC)* (\$60)
Note - 4510 Series is available as 4511 (Adjustable 1-5) or 4516 (Size 6 Only - Not ADA Compliant)
For parts & accessories, see page 60.

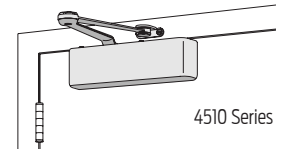

4510T Series - Surface Mount (Requires Handing)

| | | | | | |
|--------------------|-----|-------|---------|---------|----|
| 4511T, 4513T-4514T | STD | \$680 | \$1,075 | \$1,155 | 15 |
|--------------------|-----|-------|---------|---------|----|

Add for; Advanced Variable Backcheck (AVB) (\$25), Special Rust Inhibitor (SRI) (\$40), Custom Powder Finish (RAL__)* (\$40), Brite Metallic (MTLPC)* (\$60)
For parts & accessories, see page 60.

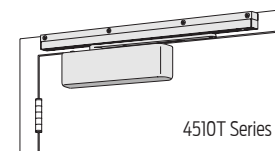

4630 Series - Surface Mount

| | | | | | |
|------|-----|---------|---------|---------|----|
| 4631 | STD | \$5,830 | \$6,225 | \$6,480 | 40 |
|------|-----|---------|---------|---------|----|

Add for; TORX Fasteners (TORX) (\$15), Custom Powder Finish (RAL__)* (\$40), Brite Metallic (MTLPC)* (\$60)
Note - Optional Concealed On/Off Switch (CS) Available (\$0) - Please Specify.
See pages 30-47 for actuators & accessories.
For parts & accessories, see page 60.

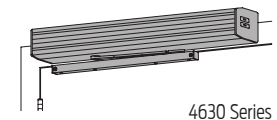

4640 Series - Surface Mount

| | | | | | |
|------|------|---------|---------|---------|----|
| 4642 | REG | \$5,755 | \$6,150 | \$6,405 | 40 |
| 4642 | LONG | 5,760 | \$6,155 | \$6,410 | 40 |

Add for; TORX Fasteners (TORX) (\$15), Custom Powder Finish (RAL__)* (\$40), Brite Metallic (MTLPC)* (\$60)
Note - Optional Concealed On/Off Switch (CS) Available (\$0) - Please Specify.
See pages 30-47 for actuators & accessories.
For parts & accessories, see page 61.

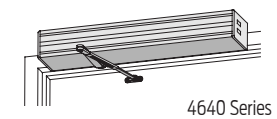

Indicates products that have EPD documentation available and meet LEED v4.

COMPLETE DOOR CLOSERS

PRICE LIST

| CLOSER SERIES | | STANDARD POWDER COAT FINISHES | PLATED FINISHES | | | S H E E P I N G |
|---------------|----------|--|-----------------|-----------------------|-------------------------|--------------------------------------|
| SERIES NUMBER | ARM TYPE | AL (689) DKBRZ (695) BRASS (696) LTBRZ (691) STAT (690) BLACK (693) | US26D | US 3 US 4 US 10 | US 11 US 15 US 26 | |



4810 Series - Surface Mount

| | | | | |
|--------------|----------------|---------|---------|----|
| 4811.....STD | \$2,245 | \$2,640 | \$2,895 | 19 |
|--------------|----------------|---------|---------|----|

Add for; Custom Powder Finish (RAL___)* (\$40), Brite Metallic (MTLPC)* (\$60)
For parts & accessories, see page 61.

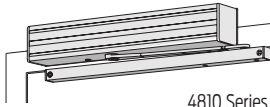

4810 Series



4820 Series - Surface Mount

| | | | | |
|---------------|----------------|---------|---------|----|
| 4822.....REG | \$2,170 | \$2,565 | \$2,820 | 19 |
| 4822.....LONG | 2,175 | 2,570 | 2,825 | 19 |

Add for; Custom Powder Finish (RAL___)* (\$40), Brite Metallic (MTLPC)* (\$60)
Closer price includes 4820-18 plate for regular mount or 4820-18G (please specify) plate for flush mount application.
For parts & accessories, see page 61.

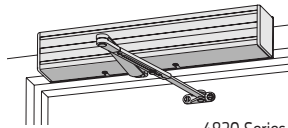

4820 Series



4840 Series - Surface Mount

| | | | | |
|----------------|----------------|---------|---------|----|
| 4841.....EDA | \$2,210 | \$2,605 | \$2,860 | 20 |
| 4841.....CUSH | 2,240 | 2,635 | 2,890 | 20 |
| 4841.....SCUSH | 2,315 | 2,710 | 2,965 | 20 |

Add for; Custom Powder Finish (RAL___)* (\$40), Brite Metallic (MTLPC)* (\$60)
See pages 24-25 for control boxes and compressors. Also, see pages 30-47 for actuators, tubing, & accessories.
For parts & accessories, see page 61.

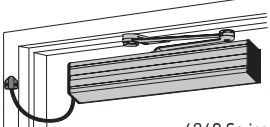

4840 Series
Shown w/4840-459 Door Loop (LCN)

5010 Series - Concealed (Requires Handing)

| | | | | |
|-------------------|--------------|---------|---------|----|
| 5011-5016.....REG | \$630 | \$1,140 | \$1,290 | 12 |
| 5011-5016.....H | 630 | 1,140 | 1,290 | 13 |

Add for; Delay Action (DEL) (\$45), TORX Fasteners (TORX) (\$15), Special Rust Inhibitor (SRI) (\$40), Custom Powder Finish (RAL___)* (\$40), Brite Metallic (MTLPC)* (\$60)
For parts & accessories, see page 61.

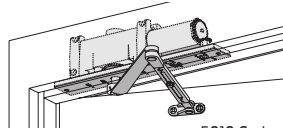

5010 Series

5030 Series - Concealed (Requires Handing)

| | | | | |
|-------------------------|----------------|---------|---------|----|
| 5031, 5033-5036.....REG | \$1,055 | \$1,565 | \$1,715 | 14 |
| 5031, 5033-5036.....H | 1,055 | 1,565 | 1,715 | 14 |

Add for; TORX Fasteners (TORX) (\$15), Special Rust Inhibitor (SRI) (\$40), Custom Powder Finish (RAL___)* (\$40), Brite Metallic (MTLPC)* (\$60)
For parts & accessories, see page 62.

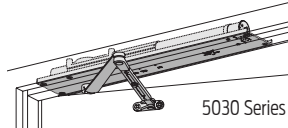

5030 Series

6030 Series - Concealed/Double Acting

| | | | | |
|------------------------|----------------|---------|---------|----|
| 6031-6035.....BUMPER | \$1,360 | \$1,870 | \$2,020 | 17 |
| 6031-6035.....H BUMPER | 1,390 | 1,900 | 2,050 | 17 |

Add for; TORX Fasteners (TORX) (\$15), Special Rust Inhibitor (SRI) (\$40), Custom Powder Finish (RAL___)* (\$40), Brite Metallic (MTLPC)* (\$60)
For parts & accessories, see page 62.

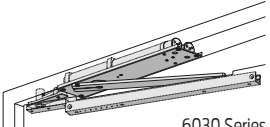

6030 Series
Shown w/ 7253 Pivot (Ives)

COMPLETE DOOR CLOSERS

PRICE LIST

| CLOSER SERIES | | STANDARD POWDER COAT FINISHES | PLATED FINISHES | | S H E E T P I G H T |  April 2020 |
|---------------|----------|-------------------------------|-----------------|-----|--|--|
| SERIES NUMBER | ARM TYPE | ANCLR ANDKB | N/A | N/A | | |



9130 Series - Surface Mount

9131.....STD (Pull) **\$3,905**

27" cover (MC) is standard - Optional 'Full Cover' (FC) (36") available (please specify)

Add for Full Cover (FC) (\$100)
See pages 30-47 for actuators & accessories.
For parts & accessories, see page 62.

Plated finish not available
ANCLR or ANDKB

38

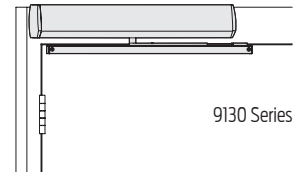

9130 Series



9140 Series - Surface Mount

9142.....REG (Push) **\$3,830**
9142.....LONG (Push) **3,835**

27" cover (MC) is standard - Optional 'Full Cover' (FC) (36") available (please specify)

Add for Full Cover (FC) (\$100)
See pages 30-47 for actuators & accessories.
For parts & accessories, see page 62.

Plated finish not available
ANCLR or ANDKB
ANCLR or ANDKB

38

38

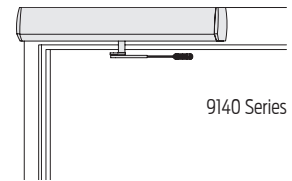

9140 Series



9150 Series - Surface Mount

9153.....REG2 (Push) **\$7,775**
9153.....LONG2 (Push) **7,785**

72" cover (MC) is standard. Additional lengths are not available.

See pages 30-47 for actuators & accessories.
For parts & accessories, see page 62.

Plated finish not available
ANCLR or ANDKB
ANCLR or ANDKB

85

85

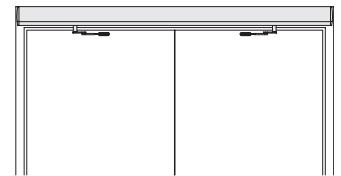

9150 Series

COMPLETE DOOR CLOSERS

PRICE LIST

| CLOSER SERIES | | STANDARD POWDER COAT FINISHES | PLATED FINISHES | | S H E E T P I N C H E S E |  |
|---------------|----------|-------------------------------|-----------------|-----|---|---|
| SERIES NUMBER | ARM TYPE | ANCLR ANDKB | N/A | N/A | | |



9530 Series - Surface Mount (Requires Handing)

9531.....STD (Pull) **\$4,925**

Header lengths available 33" to 48" (please specify).

Angle Brackets (**HL/B**) are standard, End Dress Plates (**HL/D**) are optional (please specify).

STD arm has 2 3/4" spindle center.

Add for; Double Door Header (49" to 98" – please specify) (**DD**) (**\$250**)

See pages 30-47 for actuators & accessories.

For parts & accessories, see page 62.

Plated finish not available
ANCLR or ANDKB

78

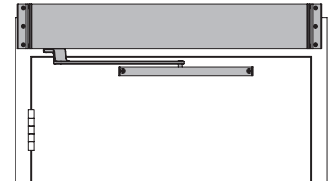

9530 Series



9540 Series - Surface Mount (Requires Handing)

9542REG (Push) **\$4,840**

9542LONG (Long Push) **4,840**

Header lengths available 33" to 48" (please specify).

Angle Brackets (**HL/B**) are standard, End Dress Plates (**HL/D**) are optional (please specify).

REG or LONG arm has 2 3/4" spindle center.

Optional 12 1/4" spindle available (requires minimum 43" header).

Add for; Double Door Header (49" to 98" – please specify) (**DD**) (**\$250**)

See pages 30-47 for actuators & accessories.

For parts & accessories, see page 63.

Plated finish not available

ANCLR or ANDKB

ANCLR or ANDKB

78

78

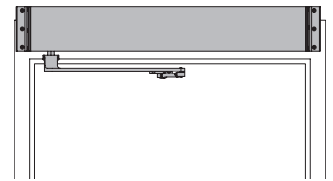

9540 Series



9550 Series - Surface Mount (DE Requires Handing) Plated finish not available

9553.....REG2 (Push Pair) **\$8,100**

9553.....LONG2 (Long Push Pair) **8,100**

9553.....STD2 (Pull Pair) **8,250**

9553.....REG/STD (Double Egress) **8,175**

Header lengths available 52" to 98" (please specify) on operators with REG or LONG (push) arms.

Header lengths available 60" to 98" (please specify) on operators with STD (pull) arms.

Header lengths available 60" to 98" (please specify) on operators with REG/STD (double egress) arms.

Angle Brackets (**HL/B**) are standard, End Dress Plates (**HL/D**) are optional (please specify).

REG, LONG, STD or REG/STD has 2 3/4" spindle center.

Optional 12 1/4" spindle available (requires minimum 71" header).

See pages 30-47 for actuators & accessories.

For parts & accessories, see page 63.

ANCLR or ANDKB

ANCLR or ANDKB

ANCLR or ANDKB

ANCLR or ANDKB

155

155

155

155

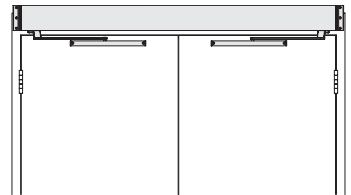

9550 Series



9560 Series - Surface Mount (DE Requires Handing) Plated finish not available

9563REG2 (Push Pair) **\$9,800**

9563LONG2 (Long Push Pair) **9,800**

9563STD2 (Pull Pair) **9,950**

9563REG/STD (Double Egress) **9,875**

Header lengths available 65" to 98" (please specify) on operators with REG or LONG (push) arms.

Header lengths available 65" to 98" (please specify) on operators with STD (pull) arms.

Header lengths available 65" to 98" (please specify) on operators with REG/STD (double egress) arms.

Angle Brackets (**HL/B**) are standard, End Dress Plates (**HL/D**) are optional (please specify).

REG, LONG, STD or REG/STD has 2 3/4" spindle center.

Optional 12 1/4" spindle available (requires minimum 84" header).

See pages 30-47 for actuators & accessories.

For parts & accessories, see page 63.

ANCLR or ANDKB

ANCLR or ANDKB

ANCLR or ANDKB

ANCLR or ANDKB

155

155

155

155

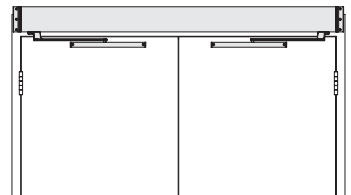

9560 Series

SEM SERIES MAGNETS

PRICE LIST

| SPECIALTY PRODUCTS | | STANDARD POWDER COAT FINISHES | S H I P P I N G |  <h1 style="margin: 0;">April 2020</h1> |
|--------------------|-------------|-------------------------------------|--------------------------------------|--|
| PRODUCT NUMBER | DESCRIPTION | AL (689) DKBRZ (695) | | |

SEM7800 Series Magnet Extension Kits

SEM7810-517..... SEM Extension Kit (55 pcs) **\$1,020** 8

Note - Extension Kit includes 1/2" extensions (10), 3/4" extensions (10), 1" extensions (10), 2" extensions (5) & ball pivot/connector links (20 ea). Individual extensions & ball pivot/connector links are available, please see page 50 in this price book for part number and list price.

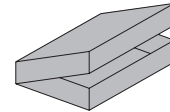

SEM7810



SEM7800 Series Magnets

SEM7820..... Floor Mount Magnet (Single Side) **\$715** 5

Low Profile Armature, Metal Housing,
Tri Voltage (12v/24v/120v) w/ 35lbs. holding force.

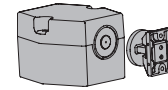

SEM7820

SEM7830..... Wall Mount Magnet **405** 4

Low Profile Armature, Metal Housing,
Tri Voltage (12v/24v/120v) w/ 35lbs. holding force.

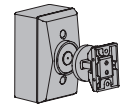

SEM7830

SEM7840..... Recessed Wall Mount Magnet **405** 4

Low Profile Armature, Metal Housing,
Tri Voltage (12v/24v/120v) w/ 35lbs. holding force.

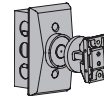

SEM7840

SEM7850..... Recessed Wall Mount Magnet **405** 4

Standard Profile Armature, Metal Housing,
Tri Voltage (12v/24v/120v) w/ 35lbs. holding force.
For parts & accessories, see page 50.

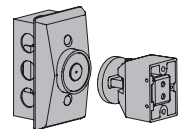

SEM7850

PAH60, PAINT AND FASTENERS

PRICE LIST

| SPECIALTY PRODUCTS | | STANDARD POWDER COAT FINISHES | PLATED FINISHES | | | S H E E P I N G |  |
|--------------------|-------------|--|-----------------|-----------------------|-------------------------|--------------------------------------|---|
| PRODUCT NUMBER | DESCRIPTION | AL (689) DKBRZ (695) BRASS (696) LTBRZ (691) STAT (690) BLACK (693) | US26D | US 3 US 4 US 10 | US 11 US 15 US 26 | | |

Parallel Arm Holder

PAH60 (Handed) Door Holder

\$140

\$365

\$435

3

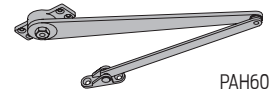

PAH60

Force Gauge

ADA/FG Force Gauge

\$60

1/2



ADA/FG

LCN Spray Paint - Available in single cans or cases of 6 (same color) cans

Can Spray Paint

\$30

Per can

1

Case Spray Paint

130

Per case (6 cans, same color)

4

Fasteners - Individual & Sets

SRT (1 ea.) SRT Screw (1 ea.)

\$1

Self reaming & tapping screw.
Size required. 1 ea.

SRT (Set of 4 ea.) SRT Screw (4 ea.)

3

Self reaming & tapping screw.
Size required. 4 ea.

MS (1 ea.) Machine Screw (1 ea.)

1

3

5

Machine screw. Size required. 1 ea.

MS (Set of 4 ea.) Machine Screw (4 ea.)

3

10

15

Machine screw. Size required. 4 ea.

WS (1 ea.) Wood Screw (1 ea.)

1

3

5

Wood screw. Size required. 1 ea.

WS (Set of 4 ea.) Wood Screw (4 ea.)

3

10

13

Wood screw. Size required. 4 ea.

TORX (1 ea.) TORX Screw (1 ea.)

3

10

13

TORX machine screw. Size required. 1 ea.

TORX (Set of 4 ea.) TORX Screw (4 ea.)

5

15

20

TORX machine screw. Size required. 4 ea.

TB 1 3/4" (1 ea.) Thru Bolt, Female

2

7

10

Through bolt. 1 3/4" length.

TB 1 3/8" (1 ea.) Thru Bolt, Female

2

7

10

Through bolt. 1 3/8" length

TB 1 5/8" (1 ea.) Thru Bolt, Female

2

7

10

Through bolt. 1 5/8" length

TB 1 3/4" (Set of 4 ea.) Thru Bolt, Female (4 ea.)

5

20

25

Through bolt. Set of 4 ea. Size required

TB 1 3/8" (Set of 4 ea.) Thru Bolt, Female (4 ea.)

5

20

25

Through bolt. Set of 4 ea. Size required.

TB 1 5/8" (Set of 4 ea.) Thru Bolt, Female (4 ea.)

5

20

25

Through bolt. Set of 4 ea. Size required.

TB/MS (1 ea.) TB(1) & MS(1)

3

7

10

TB & MS. Set of 1 ea.

TB/MS (Set of 4 ea.) TB(4) & MS(4)

6

24

30

Size and Series required.
TB & MS. Set of 4 ea.

Torx (Security) Driver Bits

T-10 TORX Bit Torx Bit, T-10

\$14

TORX driver bit, size T-10.

T-15 TORX Bit Torx Bit, T-15

14

TORX driver bit, size T-15.

T-20 TORX Bit Torx Bit, T-20

14

TORX driver bit, size T-20.

T-25 TORX Bit Torx Bit, T-25

14

TORX driver bit, size T-25.

T-27 TORX Bit Torx Bit, T-27

14

TORX driver bit, size T-27.

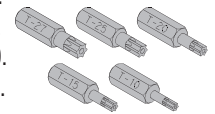

Adjustment Wrenches

T1157 Hold Open Wrench

\$5

Hold Open Adjustment Wrench

Green Hex Wrenches - NOW AVAILABLE!

One end has 3/32" hex for regulation valve adjustment and cover attachment. The other end has 5/32" hex for spring power adjustment.

Great for training seminars.

GHW1 Green Hex Wrench

\$9 Each

Green Hex Wrench. 1 Each.

GHW12 Green Hex Wrench

\$80 / Pack of 12

Green Hex Wrench. Pack of 12

GHW100 Green Hex Wrench

\$600 / Pack of 100

Green Hex Wrench. Pack of 100

CONTROL BOXES PRICE LIST

| CONTROL BOXES & COMPRESSORS | PRODUCT DESCRIPTION | LIST PRICE | S H I P P I N G |  |
|-----------------------------|---------------------|------------|--------------------------------------|---|
| PRODUCT NUMBER | | | | |

7980 Series Control Boxes

| | | | |
|--------------|--|----------------|----|
| 7981..... | Control Box, Pnuematic, Internal Compressor. Self-contained control box/compressor combination for single door application. Includes -3960 Compressor Assembly. | \$3,250 | 27 |
| 7981ES..... | Control Box, Pnuematic, Electric Strike (ES) Relay, Internal Compressor. Self-contained control box/compressor combination for single door application. Includes -3960 Compressor Assembly, -3390A Relay. | 3,775 | 27 |
| 7982..... | Control Box, Pnuematic, Internal Compressor Self-contained control box/compressor combination for either independent or simultaneous operation of two (2) door leaves. Includes -3960 Compressor Assembly. | 4,600 | 34 |
| 7982S..... | Control Box, Pnuematic, Sequential (S) Feature, Internal Compressor. Self-contained control box/compressor combination for independent, simultaneous or sequential operation of two (2) door leaves. Includes -3960 Compressor Assembly, -3426 Sequencer Card. | 5,000 | 34 |
| 7982ES..... | Control Box, Pnuematic, Electric Strike (ES) Relays, Internal Compressor. Self-contained control box/compressor combination for independent or simultaneous operation of two (2) door leaves. Includes -3960 Compressor Assembly, -3390A & -3390B Relays. | 5,525 | 34 |
| 7982SES..... | Control Box, Pnuematic, Sequential (S) Feature, Electric Strike (ES) Relays, Internal Compressor. Self-contained control box/compressor combination for independent, simultaneous or sequential operation of two (2) door leaves. Includes -3960 Compressor Assembly, -3390A & -3390B Relays, -3426 Sequencer Card. | 5,875 | 34 |

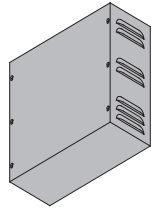

7980 Series Control Box
(15" x 15" x 6")

7900 Series Control Boxes

| | | | |
|--------------|--|----------------|----|
| 7901..... | Control Box, Pnuematic Single door application or independent control of single door in multiple door systems. Two door leaves can be operated, if activated simultaneously. Requires a separate 900 Series compressor. | \$2,225 | 14 |
| 7901ES..... | Control Box, Pnuematic Electric Strike (ES) Relay. Single door application or independent control of single door in multiple door systems. Two door leaves can be operated, if activated simultaneously. Includes -3390A Relay. Requires a separate 900 Series compressor. | 2,750 | 14 |
| 7902..... | Control Box, Pnuematic Independent operation of two (2) door leaves or simultaneous and/or sequential operation of four (4) door leaves. Requires a separate 900 Series compressor. | 3,050 | 15 |
| 7902S..... | Control Box, Pnuematic, Sequential (S) Feature Independent operation of two (2) door leaves or simultaneous operation and/or sequential operation of four (4) door leaves. Includes -3426 Sequencer Card. Requires a separate 900 Series compressor. | 3,450 | 15 |
| 7902ES..... | Control Box, Pnuematic, Electric Strike (ES) Relays Independent operation of two (2) door leaves or simultaneous of four (4) door leaves. Includes -3390A & -3390B Relays. Requires a separate 900 Series compressor. | 4,000 | 15 |
| 7902SES..... | Control Box, Pnuematic, Sequential (S), Electric Strike (ES) Relays Independent operation of two (2) door leaves or simultaneous and/or sequential operation of four (4) door leaves. Includes -3390A & -3390B Relays, -3426 Sequencer Card. Requires a separate 900 Series compressor. | 4,350 | 15 |

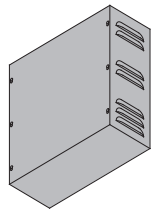

7900 Series Control Box
(15" x 15" x 6")

Note - Locate a 7980 Series Control Box within 50 linear tubing feet of the door. Locate a 7900 Series Control Box within 100 linear tubing feet of the door. Use -925 Pnuematic Tubing to connect operator and control box. 7900 Series Control Boxes require a separate air source, LCN 900 Series Compressors are recommended. For parts & accessories, see pages 28-29.

CONTROL BOXES AND COMPRESSORS

PRICE LIST

| CONTROL BOXES & COMPRESSORS | | | S H I P P I N G |  |
|-----------------------------|---------------------|------------|--------------------------------------|---|
| PRODUCT NUMBER | PRODUCT DESCRIPTION | LIST PRICE | | |

7940 Series Control Boxes - (Requires LCN 900 series compressor)

| | | | |
|--------------|--|----------------|----|
| 7949 | Control Box, Pneumatic, Auxiliary 'Blow-Open' Control box works with or without 7901/7902 Series Control Box and one or two pneumatic Auto Equalizers. Controlled by the smoke evacuation system, the 7949 Series Control Box will open the door(s) to allow fresh air into building. | \$1,850 | 14 |
| 7949ES | Control Box, Pneumatic, Auxiliary 'Blow-Open', Electric Strike (ES) Relay. Auxiliary 'blow-open' control box works with or without 7901ES/7902ES Series Control Box and one or two pneumatic Auto Equalizers. Controlled by the smoke evacuation system, the 7949 Series Control Box will unlock and open the door(s) to allow fresh air into building. | 2,300 | 14 |

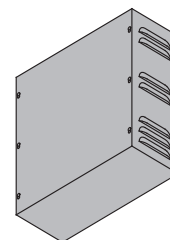

7940 Series Control Box
(15" x 15" x 6")

Note - A 'blow-open' system requires a separate air source. A 'blow-open' system that includes an automatic or power operator function also requires a separate air source and is limited to the operation of two (2) door leaves. In both cases, the LCN 900 Series Compressors are recommended. 7940 Series Control Boxes should be installed within 100 linear tubing feet of the automatic operator(s).
For parts & accessories, see pages 28-29.

CONTROL BOX COMPONENTS PRICE LIST

| CONTROL BOXES & COMPRESSORS | | LIST PRICE | PRODUCT DESCRIPTION | |
|-----------------------------|-------------|------------|---------------------|--|
| PRODUCT NUMBER | DESCRIPTION | | | |

Control Box Components

| | | | | |
|------|---------------------|----------------|--|---------|
| 293G | Muffler | \$30 | Exhaust muffler for 7901, 7902, 7981, or 7982 Series Control Boxes. | |
| 319 | Fitting, "T" | 3 | "T" fitting to connect 925 pneumatic tubing. | |
| 320 | Fitting, "Inline" | 3 | "Inline" fitting to connect 925 pneumatic tubing. | |
| 329 | Air Filter Assembly | 70 | Replacement inlet air filter for the 7981 or 7982 Series Control Boxes. | |
| 329G | Air Filter Assembly | 230 | Replacement inlet air filter for the 7901 or 7902 Series Control Boxes. Includes -929 Air Filter Assembly. | |
| 900 | Power Supply, 10T | 530 | Main power supply/input board for the 7901, 7902, 7981, & 7982 Series Control Boxes. Ten (10) terminals. | 900 |
| 903 | Timer Module | 235 | 0-30 second timer module for 7901, 7902, 7981, & 7982 Series Control Box. Plugs into the -900 Power Supply Board. | 903 |
| 925 | Pneumatic Tubing | 2.00/ft | Flexible pneumatic tubing with an 1/8" inner diameter & 1/4" outer diameter. Specify number of linear feet required when ordering. | |
| 929 | Filter & Seal | 30 | Internal filter & seal component to the 329G Air Filter Assembly. | |
| 941 | Valve Assembly | 800 | Regulator valve assembly for the 7901 series control box. | |
| 941C | Valve Assembly | 800 | Regulator valve assembly for the 7949 series control box. | |
| 942 | Valve Assembly | 1,550 | Regulator valve assembly for the 7902 series control box. | |
| 962 | Isolator | 25 | Rubber isolator for 7981 or 7982 compressor (-3960) assembly. | |

Control Box Components

| | | | | |
|-------|-----------------------------|--------------|--|-----------|
| 3299A | Solenoid Assembly Valve 'A' | 450 | Air valve assembly for the 7981 Series Control Box or the 'A' circuit valve assembly in the 7982 Series Control Box. | |
| 3299B | Solenoid Assembly Valve 'B' | 490 | Air valve assembly for the 'B' circuit in the 7982 Series Control Box. | 3299A |
| 3328 | Copper Coupler | 25 | Converts pneumatic tubing connection to copper. | |
| 3390A | 'A' Relay Package | 525 | Electric strike (ES) relay for 7901 and 7982 Series Control Boxes or the 'A' circuit ES relay assembly used in the 7902 and 7982 Series Control Boxes. Can be added to a standard control box to convert to ES operation. Includes -390 Relay, relay base and wire harness. The 3390A is included when either a 7901ES, 7902ES, 7981ES or 7982ES is ordered. | |
| 3390B | 'B' Relay Package | 525 | Electric strike (ES) relay for 'B' circuit in either the 7902 or 7982 Series Control Boxes. Can be added to a standard control box to convert to ES operation. Includes -390 Relay, relay base and wire harness. The 3390B is included when either a 7902ES or 7982ES is ordered. | 3426 |
| 3390C | 'C' Relay Package | 525 | Electric strike (ES) relay assembly for the 7949 series 'blow-open' control box. Includes -390C Relay, relay base and wire harness. The 3390C is included when a 7949ES is ordered. | 3426 |
| 3426 | Sequencer Card | 350 | Dual, 0-30 second timer module for 7902 or 7982 Series Control Box. Can be added to a standard 7902 or 7982 Series Control Box to convert box to sequential operation. -3426 Sequencer card is included when either a 7902S or 7982S Series Control Box is ordered. | 3426 |
| 3592 | Compressor Service Kit | 75 | Service kit for air pressure adjustment in the either the 7981 or 7982 Series Control Box. | |
| 3960 | Compressor Assembly | 2,000 | Internal air pump assembly for the 7981 or 7982 Series Control Box. -3960 Compressor Assembly includes starter capacitor, -962 Isolators and -329 Air Filter Assembly. | 3960 |

CONTROL BOX COMPONENTS

Control Box Components



293G



329G



329

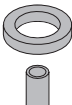

929



962

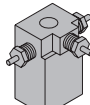

3299A



3299B



3390A

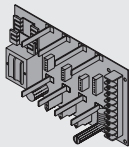

900

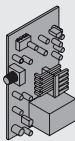

903

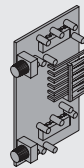

3426

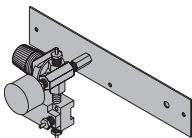

941

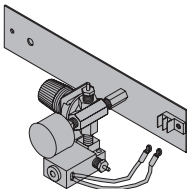

941C

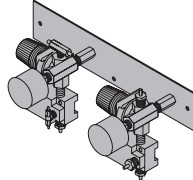

942



925

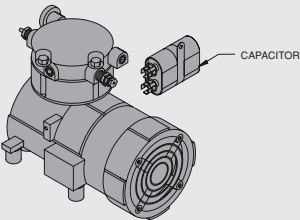

3960

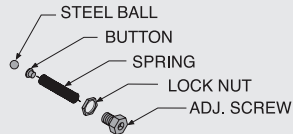

3592

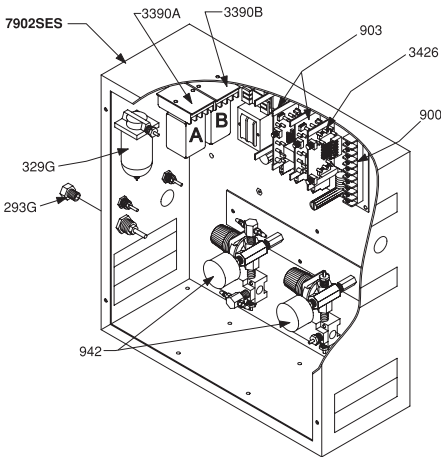

7902SES

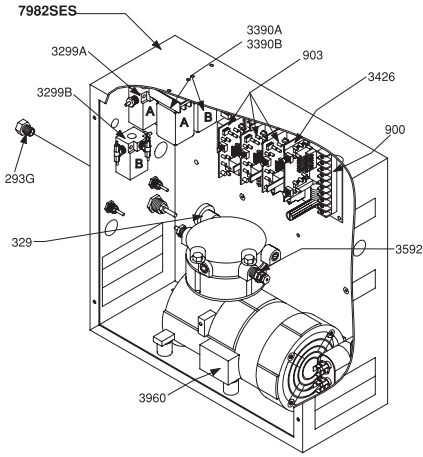

7982SES

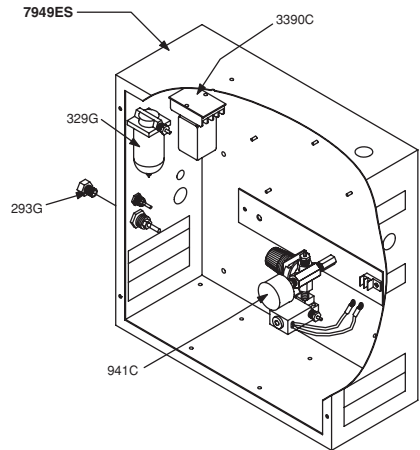

7949ES

Actuator/Sensor Quick Find PRICE LIST

| ACTUATOR/SENSOR QUICK FIND GUIDE | | LIST PRICE | PRODUCT DESCRIPTION |  |
|----------------------------------|----------------|------------|---|---|
| PRODUCT NUMBER | ITEM PAGE(S) | | | |
| 8310-800 | 40 | \$25 | Ring, Weather, 4½" Round | |
| 8310-801 | 40 | 25 | Ring, Weather, 4½" x 4½" | |
| 8310-802 | 40 | 25 | Ring, Weather, 6" Round | |
| 8310-804-1 | 42 | 1,300 | Sensor, Door Mount, Safety | |
| 8310-804-2 | 42 | 1,775 | Sensor, Door Mount, Safety | |
| 8310-805 | 44 | 60 | Switch, Door Position | |
| 8310-805C | 44 | 60 | Switch, Door Position | |
| 8310-806K | 48 | 220 | Switch, Key | |
| 8310-806R | 48 | 220 | Switch, Rocker | |
| 8310-807 | 48 | 220 | Filter, Line | |
| 8310-813 | 34 | 950 | Actuator, Wall Mount, 4¾" x 4¾" | |
| 8310-818 | 32 | 185 | Actuator, Jamb Mount, Logo, 1½" x 4¾" | |
| 8310-818T | 32 | 185 | Actuator, Jamb Mount, Logo, Text, 1½" x 4¾" | |
| 8310-819F | 40 | 40 | Box Only, Jamb Mount, Flush Mount, 1½" x 4¾" | |
| 8310-819S | 40 | 40 | Box Only, Jamb Mount, Surface Mount, 1½" x 4¾" | |
| 8310-824 | 44 | 85 | Transformer | |
| 8310-824P | 44 | 85 | Transformer | |
| 8310-836T | 36 | 1,015 | Actuator, Full Length, Logo, Text, 36" x 6" | |
| 8310-836TW | 36 | 1,175 | Actuator, Full Length, Logo, Text, Wireless, 36" x 6" | |
| 8310-844 | 46 | 210 | Transmitter Kit, Wall Mount, 9v | |
| 8310-844J | 46 | 210 | Transmitter Kit, Jamb Mount, 3v | |
| 8310-845 | 48 | 340 | Relay and Door Sequencer | |
| 8310-846 | 44 | 30 | Harness, Header Mount | |
| 8310-847 | 44 | 120 | Harness, Door Mount | |
| 8310-852 | 36 | 280 | Actuator, Wall Mount, Logo, 6" Round | |
| 8310-852T | 36 | 280 | Actuator, Wall Mount, Logo, Text, 6" Round | |
| 8310-852TA | 36 | 280 | Actuator, Wall Mount, Active Logo, Text, 6" Round | |
| 8310-852TWP | 36 | 725 | Actuator, Wall Mount, Logo, Text, Wireless, Package, 6" Round | |
| 8310-852WP | 36 | 725 | Actuator, Wall Mount, Logo, Wireless, Package, 6" Round | |
| 8310-853 | 34 | 270 | Actuator, Wall Mount, Logo, 4¾" x 4¾" | |
| 8310-853T | 34 | 270 | Actuator, Wall Mount, Logo, Text, 4¾" x 4¾" | |
| 8310-853TA | 34 | 270 | Actuator, Wall Mount, Active Logo, Text, 4¾" x 4¾" | |
| 8310-853TWP | 34 | 725 | Actuator, Wall Mount, Logo, Text, Wireless, Package, 4¾" x 4¾" | |
| 8310-853WP | 34 | 725 | Actuator, Wall Mount, Logo, Wireless, Package, 4¾" x 4¾" | |
| 8310-854 | 42 | 825 | Sensor, Header Mount, Activation | |
| 8310-854ECA | 44 | 215 | Bracket, Drop Ceiling | |
| 8310-854ERA | 44 | 145 | Cover, Protective | |
| 8310-855 | 34 | 425 | Actuator, Wall Mount, Logo, Dual Vestibule | |
| 8310-856 | 32 | 215 | Actuator, Wall Mount, Logo | |
| 8310-856P | 32 | 215 | Actuator, Wall Mount, Logo | |
| 8310-856T | 32 | 215 | Actuator, Wall Mount, Logo, Text | |
| 8310-859 | 44 | 185 | Remote, Handheld | |
| 8310-861 | 46 | 210 | Transmitter, Handheld, 1 Channel | |
| 8310-862 | 46 | 210 | Transmitter, Handheld, 2 Channel | |
| 8310-863 | 46 | 210 | Transmitter, Handheld, 3 Channel | |
| 8310-864 | 46 | 210 | Transmitter, Handheld, 4 Channel | |
| 8310-865 | 32, 34, 36, 46 | 220 | Receiver | |
| 8310-866 | 46 | 950 | Post, Bollard, Accommodates Bollard Actuator, 42" x 4" x 6" | |
| 8310-866FLA | 46 | 950 | Post, Bollard, Accommodates Full Length Actuator, 42" x 4" x 6" | |
| 8310-866CAP | 46 | 155 | Cap | |

Actuator/Sensor Quick Find PRICE LIST

| ACTUATOR/SENSOR QUICK FIND GUIDE | | LIST PRICE | PRODUCT DESCRIPTION |
|----------------------------------|--------------|--------------|--|
| PRODUCT NUMBER | ITEM PAGE(S) | | |
| 8310-867F | 40 | \$175 | Box, Flush Mount, 4¾" x 4¾" |
| 8310-867S | 40 | 175 | Box, Surface Mount, 4¾" x 4¾" |
| 8310-868F | 40 | 155 | Box, Flush Mount, 4½" Round |
| 8310-868S | 40 | 155 | Box, Surface Mount, 4½" Round |
| 8310-869F | 40 | 170 | Box, Flush Mount, 6" Round |
| 8310-869S | 40 | 170 | Box, Surface Mount, 6" Round |
| 8310-874 | 40 | 385 | Escutcheon, 4½" Round |
| 8310-876 | 40 | 385 | Escutcheon, 6" Round |
| 8310-877S | 44 | 170 | Spacer, Header Mount |
| 8310-3803 | 44 | 605 | Conversion Kit, Wireless, Jamb Mount |
| 8310-3809 | 44 | 605 | Conversion Kit, Wireless, Wall Mount |
| 8310-3818TWF | 32 | 410 | Actuator, Jamb Mount, Logo, Text, Wireless, Flush, 1½" x 4¾" |
| 8310-3818TWS | 32 | 410 | Actuator, Jamb Mount, Logo, Text, Wireless, Surface, 1½" x 4¾" |
| 8310-3818WF | 32 | 410 | Actuator, Jamb Mount, Logo, Wireless, Flush, 1½" x 4¾" |
| 8310-3818WS | 32 | 410 | Actuator, Jamb Mount, Logo, Wireless, Surface, 1½" x 4¾" |
| 8310-3822T | 38 | 425 | Actuator Package, Logo, Text, 1½" x 4¾" |
| 8310-3822TW | 38 | 825 | Actuator Package, Logo, Text, Wireless, 1½" x 4¾" |
| 8310-3836T | 46 | 1,900 | Full Length Actuator / Bollard Package |
| 8310-3836TW | 46 | 2,075 | Full Length Actuator / Bollard Package, Wireless |
| 8310-3852TWF | 36 | 650 | Actuator, Wall Mount, Logo, Text, Wireless, Flush, 6" Round |
| 8310-3852TWS | 36 | 650 | Actuator, Wall Mount, Logo, Text, Wireless, Surface, 6" Round |
| 8310-3852WF | 36 | 650 | Actuator, Wall Mount, Logo, Wireless, Flush, 6" Round |
| 8310-3852WS | 36 | 650 | Actuator, Wall Mount, Logo, Wireless, Surface, 6" Round |
| 8310-3853TWB | 46 | 450 | Actuator, Bollard, Logo, Text, Wireless, 4¾" x 4¾" |
| 8310-3853TWF | 34 | 650 | Actuator, Wall Mount, Logo, Text, Flush, 4¾" x 4¾" |
| 8310-3853TWS | 34 | 650 | Actuator, Wall Mount, Logo, Text, Surface, 4¾" x 4¾" |
| 8310-3853WB | 46 | 450 | Actuator, Bollard, Logo, Wireless, 4¾" x 4¾" |
| 8310-3853WF | 34 | 650 | Actuator, Wall Mount, Logo, Wireless, Flush, 4¾" x 4¾" |
| 8310-3853WS | 34 | 650 | Actuator, Wall Mount, Logo, Wireless, Surface, 4¾" x 4¾" |
| 8310-3855WF | 34 | 995 | Actuator, Wall Mount, Logo, Wireless, Flush, Dual Vestibule, 4¾" x 4¾" |
| 8310-3855WS | 34 | 995 | Actuator, Wall Mount, Logo, Wireless, Surface, Dual Vestibule, 4¾" x 4¾" |
| 8310-3856TWF | 32 | 570 | Actuator, Wall Mount, Logo, Text, Wireless, Flush, 4½" Round |
| 8310-3856TWS | 32 | 570 | Actuator, Wall Mount, Logo, Text, Wireless, Surface, 4½" Round |
| 8310-3856WF | 32 | 570 | Actuator, Wall Mount, Logo, Wireless, Flush, 4½" Round |
| 8310-3856WS | 32 | 570 | Actuator, Wall Mount, Logo, Wireless, Surface, 4½" Round |
| 8310-3857T | 38 | 845 | Actuator Package, Logo, Text, 4¾" x 4¾" |
| 8310-3857TW | 38 | 1,495 | Actuator Package, Logo, Text, Wireless, 4¾" x 4¾" |
| 8310-3860T | 38 | 700 | Actuator Package, Logo, Text, 4½" Round |
| 8310-878 | 42 | 4,500 | Sensor Package |
| 8310-879 | 42 | 8,500 | Sensor Package |
| 8310-3860TW | 38 | 1,350 | Actuator Package, Logo, Text, Wireless, 4½" Round |
| 8310-3881 | 42 | 6,150 | Sensor Package |
| 8310-3882 | 42 | 9,999 | Sensor Package |
| 8310-3883 | 42 | 1,775 | Sensor Package |
| 8310-3888 | 44 | 40 | Harness, Safety Module |
| 8310-3889 | 44 | 540 | Safety Module Kit |
| 8310-3891 | 42 | 8,750 | Sensor Package |
| 8310-3892 | 42 | 9,999 | Sensor Package |



ACTUATORS & ACCESSORIES

PRICE LIST

| ACTUATORS & ACCESSORIES | | LIST PRICE | PRODUCT DESCRIPTION |  |
|-------------------------|-------------|------------|---------------------|---|
| PRODUCT NUMBER | DESCRIPTION | | | |

8310 Series Actuators - Jamb Mount - 1-1/2" x 4-3/4" Rectangle - Interior Installation Only

| | | | |
|--------------|----------------------|--------------|---|
| 8310-818 | Actuator, Jamb Mount | \$185 | Actuator, 1-1/2" x 4-3/4" Rectangle, Logo |
| 8310-818T | Actuator, Jamb Mount | 185 | Actuator, 1-1/2" x 4-3/4" Rectangle, Logo, Text |
| 8310-3818WF | Actuator, Jamb Mount | 410 | Actuator, 1-1/2" x 4-3/4" Rectangle, Logo, Wireless, Flush Mount Includes 8310-818 Actuator, 8310-844J Transmitter Kit, 8310-819F Flush Box. Requires 8310-865 Receiver. |
| 8310-3818WS | Actuator, Jamb Mount | 410 | Actuator, 1-1/2" x 4-3/4" Rectangle, Logo, Wireless, Surface Mount Includes 8310-818 Actuator, 8310-844J Transmitter Kit, 8310-819S Surface Box. Requires 8310-865 Receiver. |
| 8310-3818TWF | Actuator, Jamb Mount | 410 | Actuator, 1-1/2" x 4-3/4" Rectangle, Logo, Text, Wireless, Flush Mount Includes 8310-818T Actuator, 8310-844J Transmitter Kit, 8310-819F Flush Box. Requires 8310-865 Receiver. |
| 8310-3818TWS | Actuator, Jamb Mount | 410 | Actuator, 1-1/2" x 4-3/4" Rectangle, Logo, Text, Wireless, Surface Mount Includes 8310-818T Actuator, 8310-844J Transmitter Kit, 8310-819S Surface Box. Requires 8310-865 Receiver. |
| 8310-865 | Receiver | 220 | Receiver, Wireless, 1 Channel, Sequencing Feature Used in conjunction w/ Wireless Actuators & Transmitters |



8310-818



8310-818T

8310 Series Actuators - Wall Mount - 4-1/2" Round

| | | | |
|--------------|----------------------|--------------|---|
| 8310-856 | Actuator, Wall Mount | \$215 | Actuator, 4-1/2" Round, Logo |
| 8310-856T | Actuator, Wall Mount | 215 | Actuator, 4-1/2" Round, Logo, Text |
| 8310-3856WF | Actuator, Wall Mount | 570 | Actuator, 4-1/2" Round, Logo, Wireless, Flush Mount. Includes 8310-856 Actuator, 8310-844 Transmitter Kit, 8310-868F Flush Box, 8310-800 Weather Ring. Requires 8310-865 Receiver. |
| 8310-3856WS | Actuator, Wall Mount | 570 | Actuator, 4-1/2" Round, Logo, Wireless, Surface Mount Includes 8310-856 Actuator, 8310-844 Transmitter Kit, 8310-868S Surface Box, 8310-800 Weather Ring. Requires 8310-865 Receiver. |
| 8310-3856TWF | Actuator, Wall Mount | 570 | Actuator, 4-1/2" Round, Logo, Text, Wireless, Flush Mount Includes 8310-856T Actuator, 8310-844 Transmitter Kit, 8310-868F Flush Box, 8310-800 Weather Ring. Requires 8310-865 Receiver. |
| 8310-3856TWS | Actuator, Wall Mount | 570 | Actuator, 4-1/2" Round, Logo, Text, Wireless, Surface Mount Includes 8310-856T Actuator, 8310-844 Transmitter Kit, 8310-868S Surface Box, 8310-800 Weather Ring. Requires 8310-865 Receiver. |
| 8310-865 | Receiver | 220 | Receiver, Wireless, 1 Channel, Sequencing Feature Used in conjunction w/ Wireless Actuators & Transmitters |









8310-856

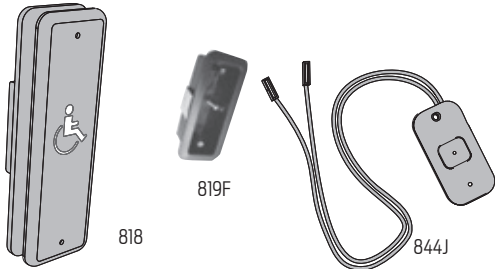
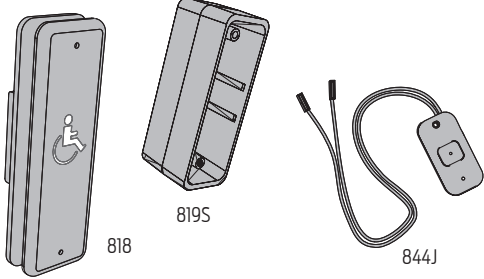

8310-856T

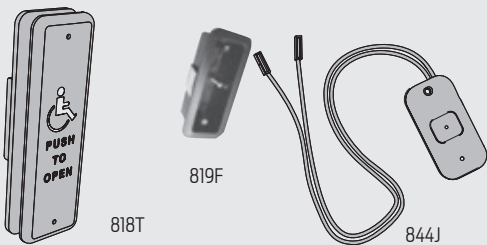
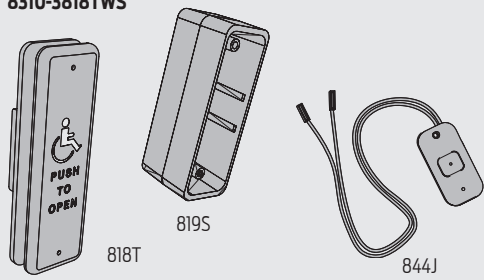
8310 Series Actuators

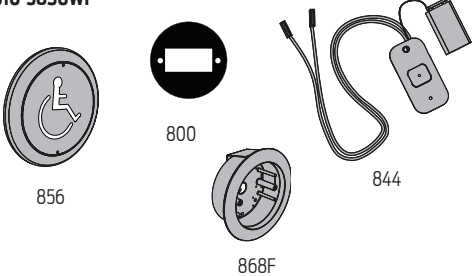
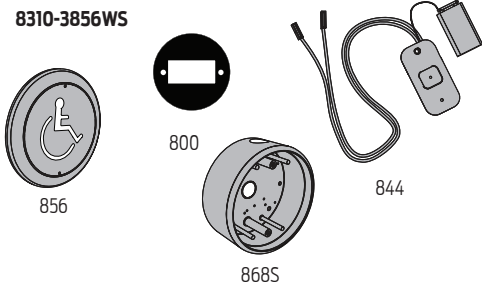

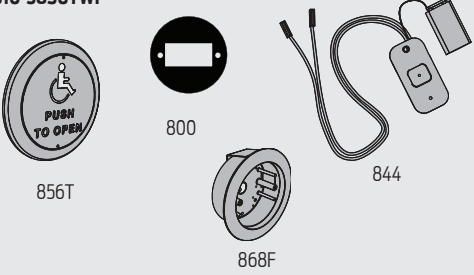
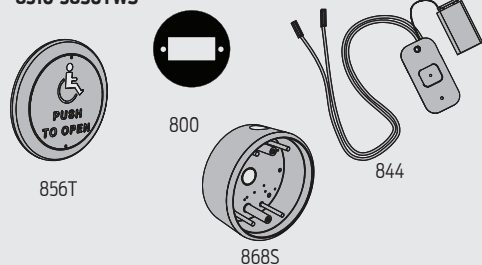



| | | |
|--|---|--|
| <p>8310-818</p>  | <p>8310-3818WF</p>  <p>818</p> | <p>8310-3818WS</p>  <p>818</p> |
| <p>8310-818T</p>  | <p>8310-3818TWF</p>  <p>818T</p> | <p>8310-3818TWS</p>  <p>818T</p> |
| <p>8310-856</p>  | <p>8310-3856WF</p>  <p>856</p> | <p>8310-3856WS</p>  <p>856</p> |
| <p>8310-856T</p>  | <p>8310-3856TWF</p>  <p>856T</p> | <p>8310-3856TWS</p>  <p>856T</p> |

ACTUATORS & ACCESSORIES

PRICE LIST

| ACTUATORS & ACCESSORIES | | LIST PRICE | PRODUCT DESCRIPTION |  |
|-------------------------|-------------|------------|---------------------|---|
| PRODUCT NUMBER | DESCRIPTION | | | |

8310 Series Actuators - Wall Mount - 4-3/4" Square

| | | | | |
|--------------|----------------------|--------------|---|---|
| 8310-853 | Actuator, Wall Mount | \$270 | Actuator, 4-3/4" Square, Logo |  |
| 8310-853T | Actuator, Wall Mount | 270 | Actuator, 4-3/4" Square, Logo, Text | |
| 8310-853TA | Actuator, Wall Mount | 270 | Actuator, 4-3/4" Square, Active Logo, Text |  |
| 8310-853WP | Actuator, Wall Mount | 725 | Actuator, 4-3/4" Square, Logo, Wireless, Surface Mount Easy mount, 'all in one', low profile, surface mount, wireless actuator. Requires 8310-865 Receiver | |
| 8310-853TWP | Actuator, Wall Mount | 725 | Actuator, 4-3/4" Square, Logo, Text, Wireless, Surface Mount Easy mount, 'all in one', low profile, surface mount, wireless actuator. Requires 8310-865 Receiver |  |
| 8310-3853WF | Actuator, Wall Mount | 650 | Actuator, 4-3/4" Square, Logo, Wireless, Flush Mount Includes 8310-853, 8310-844 Transmitter Kit, 8310-867F Flush Box, 8310-801 Weather Ring. Requires 8310-865 Receiver | |
| 8310-3853WS | Actuator, Wall Mount | 650 | Actuator, 4-3/4" Square, Logo, Wireless, Surface Mount Includes 8310-853, 8310-844 Transmitter Kit, 8310-867S Surface Box, 8310-801 Weather Ring. Requires 8310-865 Receiver |  |
| 8310-3853TWF | Actuator, Wall Mount | 650 | Actuator, 4-3/4" Square, Logo, Text, Wireless, Flush Mount Includes 8310-853T, 8310-844 Transmitter Kit, 8310-867F Flush Box, 8310-801 Weather Ring. Requires 8310-865 Receiver | |
| 8310-3853TWS | Actuator, Wall Mount | 650 | Actuator, 4-3/4" Square, Logo, Text, Wireless, Surface Mount Includes 8310-853T, 8310-844 Transmitter Kit, 8310-867S Surface Box, 8310-801 Weather Ring. Requires 8310-865 Receiver |  |
| 8310-865 | Receiver | 220 | Receiver, Wireless, 1 Channel, Sequencing Feature Used in conjunction w/ Wireless Actuators & Transmitters | |

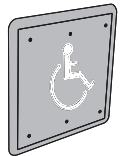

8310-853



8310-853T



8310-855

8310 Series Actuators - Wall Mount - 4-3/4" Square

| | | | |
|-------------|----------------------|--------------|--|
| 8310-813 | Actuator, Wall Mount | \$950 | Actuator, 4-3/4" Square, Touchless, Wall Mount 'K' Band Technology 'Hands Free' operation, system is activated by movement near actuator face. Mounts in 4" x 4" electrical box - Includes black plexiglass cover |
| 8310-855 | Actuator, Wall Mount | 425 | Actuator, 4-3/4" Square, Logo, Dual Vestibule |
| 8310-3855WF | Actuator, Wall Mount | 995 | Actuator, 4-3/4" Square, Logo, Dual Vestibule, Wireless, Flush Mount Includes 8310-855 Actuator, 8310-844 Transmitter (2), 8310-867F Flush Box, 8310-801 Weather Ring. Requires 8310-865 Receiver (2) |
| 8310-3855WS | Actuator, Wall Mount | 995 | Actuator, 4-3/4" Square, Logo, Dual Vestibule, Wireless, Surface Mount Includes 8310-855 Actuator, 8310-844 Transmitter (2), 8310-867S Surface Box, 8310-801 Weather Ring. Requires 8310-865 Receiver (2) |
| 8310-865 | Receiver | 220 | Receiver, Wireless, 1 Channel, Sequencing Feature Used in conjunction w/ Wireless Actuators & Transmitters |

8310 Series Actuators



8310-853

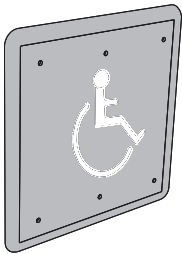

8310-3853WF



853



801

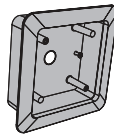

867F



844

8310-3853WS



853

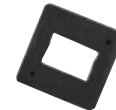

801

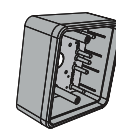

867S

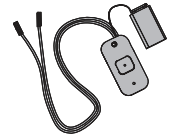

844

8310-853T

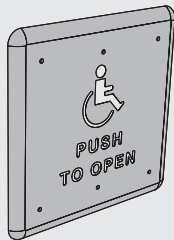

8310-3853TWF



853T

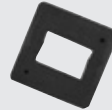

801

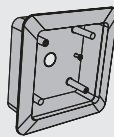

867F



844

8310-3853TWS



853T

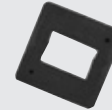

801

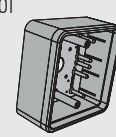

867S

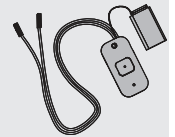

844

8310-853WP



8310-853TWP

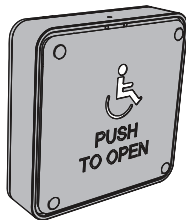

8310-813

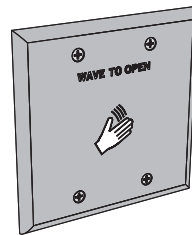

8310-865

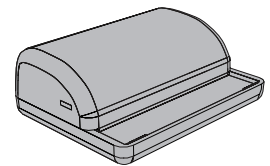

8310-855



8310-3855WF



855

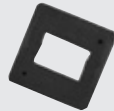

801

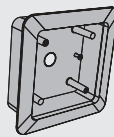

867F



844

8310-3855WS



855

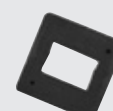

801

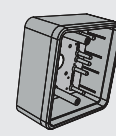

867S

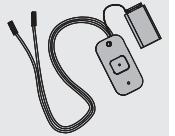





844

ACTUATORS & ACCESSORIES

PRICE LIST

| ACTUATORS & ACCESSORIES | | LIST PRICE | PRODUCT DESCRIPTION |  |
|-------------------------|-------------|------------|---------------------|---|
| PRODUCT NUMBER | DESCRIPTION | | | |

8310 Series Actuators - Wall Mount - 6" Round

| | | | | |
|--------------|----------------------|--------------|---|--|
| 8310-852 | Actuator, Wall Mount | \$280 | Actuator, 6" Round, Logo |  8310-852 |
| 8310-852T | Actuator, Wall Mount | 280 | Actuator, 6" Round, Logo, Text | |
| 8310-852TA | Actuator, Wall Mount | 280 | Actuator, 6" Round, Active Logo, Text |  8310-852T |
| 8310-852WP | Actuator, Wall Mount | 725 | Actuator, 6" Round, Logo, Wireless, Surface Mount Easy mount, 'all in one', low profile, surface mount, wireless actuator. Requires 8310-865 Receiver. | |
| 8310-852TWP | Actuator, Wall Mount | 725 | Actuator, 6" Round, Logo, Text, Wireless, Surface Mount Easy mount, 'all in one', low profile, surface mount, wireless actuator. Requires 8310-865 Receiver. |  8310-852TWP |
| 8310-3852WF | Actuator, Wall Mount | 650 | Actuator, 6" Round, Logo, Wireless, Flush Mount Includes 8310-852 Actuator, 8310-844 Transmitter Kit, 8310-869F Flush Box, 8310-802 Weather Ring. Requires 8310-865 Receiver. | |
| 8310-3852WS | Actuator, Wall Mount | 650 | Actuator, 6" Round, Logo, Wireless, Surface Mount Includes 8310-852 Actuator, 8310-844 Transmitter Kit, 8310-869S Surface Box, 8310-802 Weather Ring. Requires 8310-865 Receiver. |  8310-852WS |
| 8310-3852TWF | Actuator, Wall Mount | 650 | Actuator, 6" Round, Logo, Text, Wireless, Flush Mount Includes 8310-852T Actuator, 8310-844 Transmitter Kit, 8310-869F Flush Box, 8310-802 Weather Ring. Requires 8310-865 Receiver. | |
| 8310-3852TWS | Actuator, Wall Mount | 650 | Actuator, 6" Round, Logo, Text, Wireless, Surface Mount Includes 8310-852T Actuator, 8310-844 Transmitter Kit, 8310-869S Surface Box, 8310-802 Weather Ring. Requires 8310-865 Receiver. |  8310-852TWS |
| 8310-865 | Receiver | 220 | Receiver, Wireless, 1 Channel, Sequencing Feature Used in conjunction w/ Wireless Actuators & Transmitters | |

8310 Series Actuators - Specialty

| | | | | |
|------------|-----------------------|--------------|--|--|
| 8310-836T | Actuator, Full Length | 1,015 | Actuator, 36" x 6" Full Length, Logo, Text |  8310-836T |
| 8310-836TW | Actuator, Full Length | 1,175 | Actuator, 36" x 6" Full Length, Logo, Text, Wireless Requires 8310-865. Easy Mount, All-In-One, Low Profile Surface Mount, Wireless Actuator. | |

8310 Series Actuators

April
2020

8310-852



3852WF

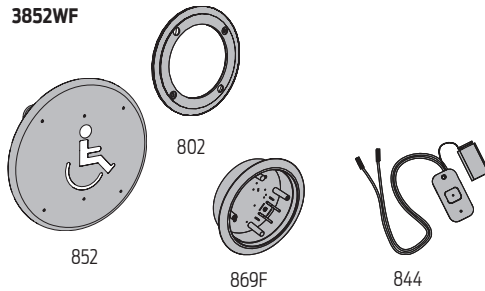

3852WS

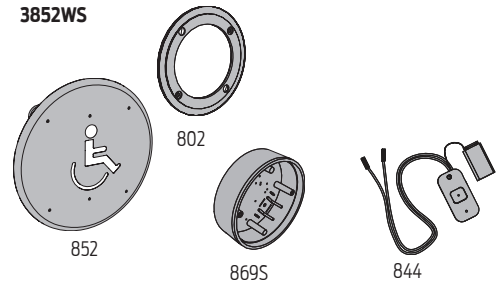

8310-852T



3852TWF

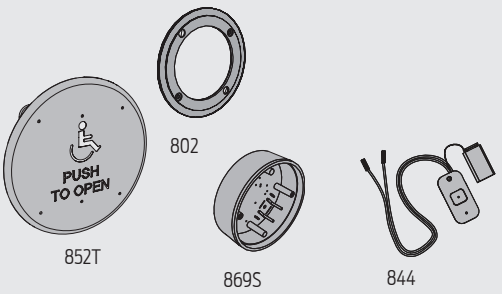
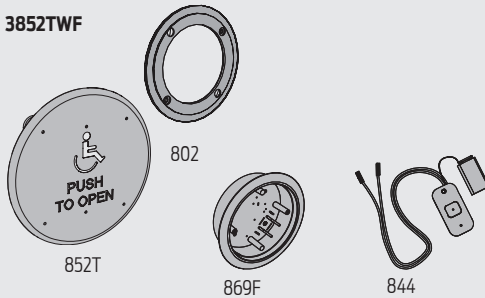

8310-852WP



8310-852TWP



8310-865

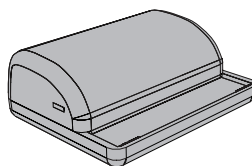

8310-836T



8310-836TW

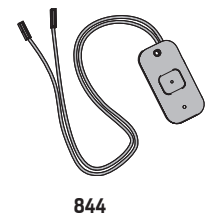
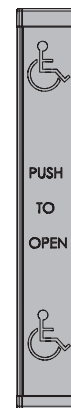

844

836T

ACTUATORS & ACCESSORIES

PRICE LIST

| ACTUATORS & ACCESSORIES | | LIST PRICE | PRODUCT DESCRIPTION |
|-------------------------|-------------|------------|---------------------|
| PRODUCT NUMBER | DESCRIPTION | | |



8310 Series Actuators - Wall Mount - 4-3/4" Square

| | | | |
|-------------|------------------|--------------|---|
| 8310-3822T | Actuator Package | \$425 | Actuator Package, 1-1/2" x 4-3/4", Jamb Mount Includes 8310-818T (2) Jamb Mount Actuator, (2) 8310-819S Surface Mount Box. Recommended for interior use only. |
| 8310-3822TW | Actuator Package | 825 | Actuator Package, 1-1/2" x 4-3/4", Wireless, Jamb Mount Includes 8310-818T (2) Jamb Mount Actuator, 8310-819S (2) Surface Mount Box, 8310-844J (2) Jamb Mount Transmitter, 8310-865 Receiver. Recommended for interior use only. |
| 8310-3860T | Actuator Package | 700 | Actuator Package, 4-1/2" Round, Wall Mount. Includes 8310-856T (2) Wall Mount Actuator, 8310-868S (2) Surface Mount Box |
| 8310-3860TW | Actuator Package | 1,350 | Actuator Package, 4-1/2" Round, Wireless, Wall Mount Includes 8310-856T (2) Wall Mount Actuator, 8310-868S (2) Surface Mount Box, 8310-800 (2) Weather Ring, 8310-844 (2) Transmitter, 8310-865 Receiver |
| 8310-3857T | Actuator Package | 845 | Actuator Package, 4-3/4" Square, Wall Mount. Includes 8310-853T (2) Wall Mount Actuator, 8310-867S (2) Surface Mount Box |
| 8310-3857TW | Actuator Package | 1,495 | Actuator Package, 4-3/4" Square, Wall Mount. Includes 8310-853T (2) Wall Mount Actuator, 8310-867S (2) Surface Mount Box, 8310-801 (2) Weather Ring, 8310-844 (2) Transmitter, 8310-865 Receiver |

8310 Series Actuator Packages

April
2020

8310-3822T

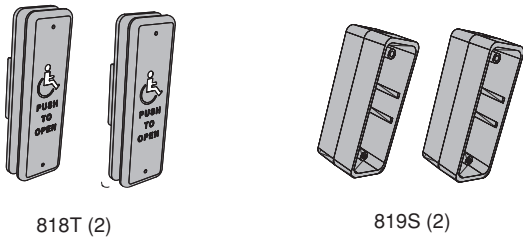

8310-3822TW

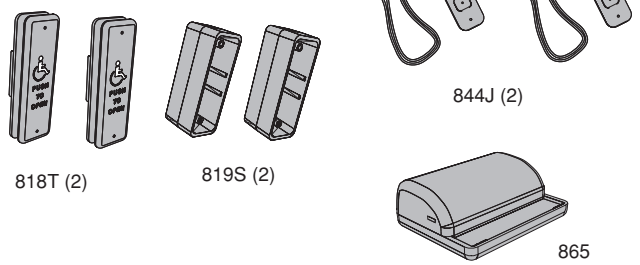

8310-3860T

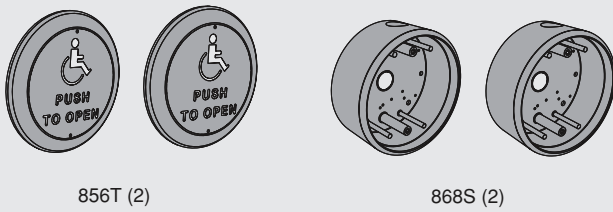

8310-3860TW

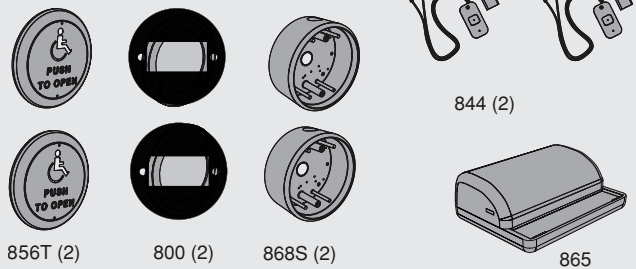

8310-3857T

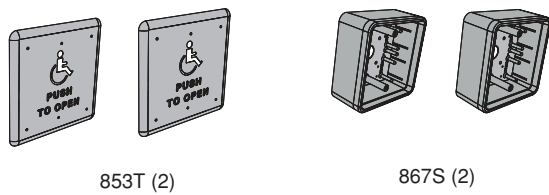

8310-3857TW

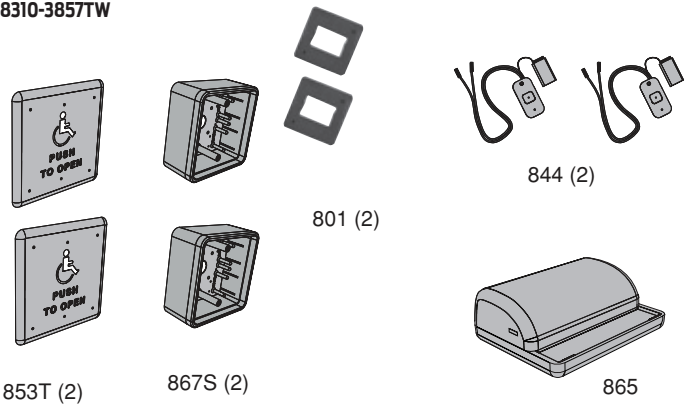

ACTUATORS & ACCESSORIES

PRICE LIST

| ACTUATORS & ACCESSORIES | | LIST PRICE | PRODUCT DESCRIPTION |  |
|-------------------------|-------------|------------|---------------------|---|
| PRODUCT NUMBER | DESCRIPTION | | | |

8310 Series Actuator Accessories

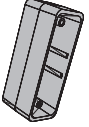
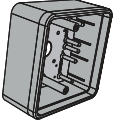
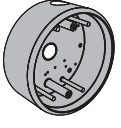
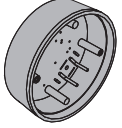
| | | | | |
|-----------|----------------------|-------------|--|--|
| 8310-800 | Ring, Weather | \$24 | Weather Ring, 4-1/2" Round Optional accessory. Can be used w/ any 4-1/2" round actuator |  8310-800 |
| 8310-801 | Ring, Weather | 24 | Weather Ring, 4-1/2" Square Optional accessory. Can be used w/ any 4-1/2" square actuator | |
| 8310-802 | Ring, Weather | 24 | Weather Ring, 6" Round Optional accessory. Can be used w/ any 6" round actuator | |
| 8310-819F | Box Only, Jamb Mount | 39 | Jamb Box Only, 1-1/2" x 4-3/4" Rectangle, Flush Mount Optional accessory. Should be used on an interior installation Can be used w/ any 1-1/2" x 4-3/4" jamb mount actuator |  8310-819S |
| 8310-819S | Box Only, Jamb Mount | 39 | Jamb Box Only, 1-1/2" x 4-3/4", Rectangle, Surface Mount Optional accessory. Should be used on an interior installation only. Can be used w/ any 1-1/2" x 4-3/4" jamb mount actuator | |
| 8310-867F | Box, Flush Mount | 170 | Box Only, 4-3/4" Square, Flush Mount Optional accessory. Can be used w/ any 4-3/4" square actuator |  8310-867S |
| 8310-867S | Box, Surface Mount | 170 | Box Only, 4-3/4" Square, Surface Mount Optional accessory. Can be used w/ any 4-3/4" square actuator | |
| 8310-868F | Box, Flush Mount | 153 | Box Only, 4-1/2" Round, Flush Mount Optional accessory. Can be used w/ any 4-1/2" round actuator |  8310-868S |
| 8310-868S | Box, Surface Mount | 153 | Box Only, 4-1/2" Round, Surface Mount Optional accessory. Can be used w/ any 4-1/2" round actuator | |
| 8310-869F | Box, Flush Mount | 165 | Box Only, 6" Round, Flush Mount Optional accessory. Can be used w/ any 6" round actuator |  8310-869S |
| 8310-869S | Box, Surface Mount | 165 | Box Only, 6" Round, Surface Mount Optional accessory. Can be used w/ any 6" round actuator | |
| 8310-874 | Escutcheon | 379 | Escutcheon, 4-1/2" Round, Decorative, Protective Optional accessory. Can be used w/ any 4-1/2" round actuator | |
| 8310-876 | Escutcheon | 379 | Escutcheon, 6" Round, Decorative, Protective Optional accessory. Can be used w/ any 6" round actuator | |

8310 Series Actuator Accessories

April
2020

8310-800

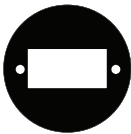

8310-801



8310-802

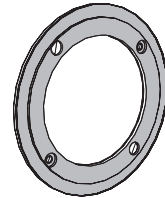

8310-819F



8310-819S

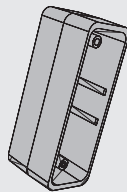

8310-867F

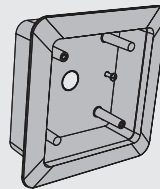

8310-867S

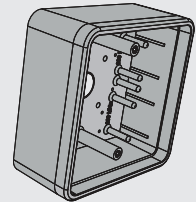

8310-868F

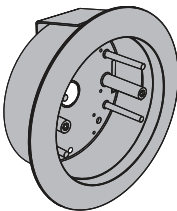

8310-868S

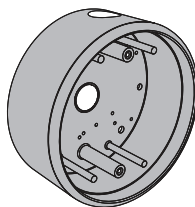

8310-869F

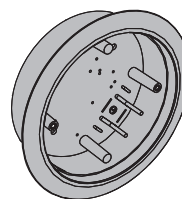

8310-869S

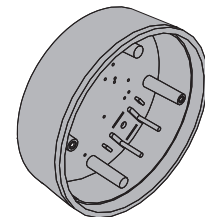

8310-874

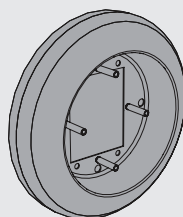

8310-876

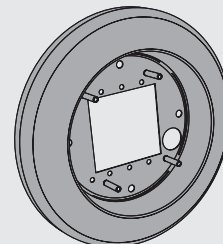

ACTUATORS & ACCESSORIES

PRICE LIST

| ACTUATORS & ACCESSORIES | | LIST PRICE | PRODUCT DESCRIPTION |  |
|-------------------------|-------------|------------|---------------------|---|
| PRODUCT NUMBER | DESCRIPTION | | | |

8310 Series Activation/Safety Sensors

| | | | |
|------------|----------------------------------|----------------|--|
| 8310-804-1 | Sensor, Door Mount, Safety | \$1,300 | Door Mount Safety Sensor, Sensor with one element Used to sense obstruction(s) on leading edge of |
| 8310-804-2 | Sensor, Door Mount, Safety | 1,775 | Door Mount Safety Sensor, Sensor with two elements Used to sense obstruction(s) on full face of door |
| 8310-854 | Sensor, Header Mount, Activation | 825 | Header Mount Activation Sensor, 'K' Band Technology |
| 8310-877 | Sensor, Header Mount, Safety | 1,575 | Header Mount Safety Sensor, 'Diffused Infrared' Technology Provides 'safety function' during door open & door closed position. Nine selectable/programmable patterns. Optional 8310-859 Handheld Remote Control can be used to program 8310-877 Sensor from a distance. Includes 8310-846 Harness. |

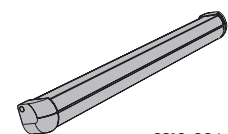

8310-804-1

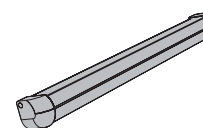

8310-804-2

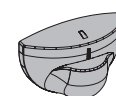

8310-854

8310 Series Activation/Safety Sensor Packages

| | | | |
|-----------|----------------|----------------|--|
| 8310-878 | Sensor Package | \$4,500 | Monitored Safety Sensor Kit for single door applications. Contains two (2) door-mounted sensors and a control hub that perform the swing door safety functions and provides the sensor monitoring required by A156.10. All wire harnesses and mounting hardware included. |
| 8310-879 | Sensor Package | 8,500 | Monitored Safety Sensor Kit for all double door applications. Contains four (4) door-mounted sensors and a control hub that perform the swing door safety functions and provides the sensor monitoring required by A156.10. All wire harnesses and mounting hardware included. |
| 8310-3881 | Sensor Package | 6,150 | Safety Sensor Package. Includes 8310-854 (2) Header Mount Activation Sensor & 8310-878 Monitored Safety Sensor Kit (Used with Senior Swing Only) |
| 8310-3882 | Sensor Package | 9,999 | Safety Sensor Package. Includes 8310-854 (2) Header Mount Activation Sensor & 8310-879 Monitored Safety Sensor Kit (Used with Senior Swing Only) |
| 8310-3883 | Sensor Package | 1,775 | Activation/Safety Sensor Package, Low Energy Convenience, Single Door. Includes 8310-804-1 Door Mount Safety Sensor, 8310-805C Door Position Switch (Concealed), 8310-845 Programmable Relay Module |
| 8310-3891 | Sensor Package | 8,750 | Activation/Safety Sensor Package, Health Care I, Simultaneous Pair Includes 8310-877 Header Mount Sensor, 8310-877S Header Mount Spacer, 8310-804-2 (4) Door Mount Sensor, 8310-847 (2) Harness. |
| 8310-3892 | Sensor Package | 9,999 | Activation/Safety Sensor Package, Health Care II, Independent Pair Includes 8310-877 (2) Header Mount Sensor, 8310-877S (2) Header Mount Spacer, 8310-804-2 (4) Door Mount Sensor, 8310-847 (2) Harness |

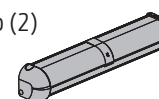

8310-877

8310 Series Activation/Safety Sensor Packages

April
2020

8310-804-1

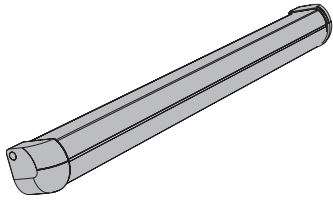

8310-804-2

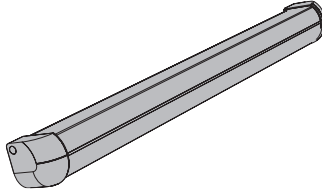

8310-854



8310-877

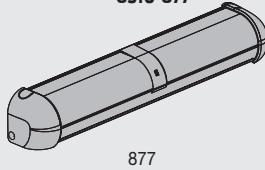

877

8310-3883



804-1

805C

845

8310-3891

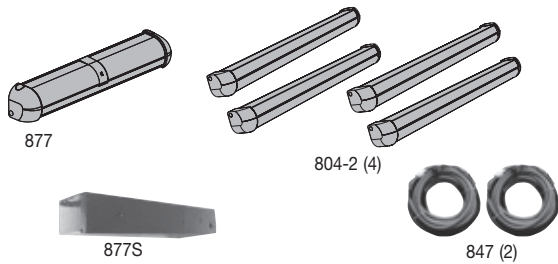

877

804-2 (4)

877S

847 (2)

8310-3892

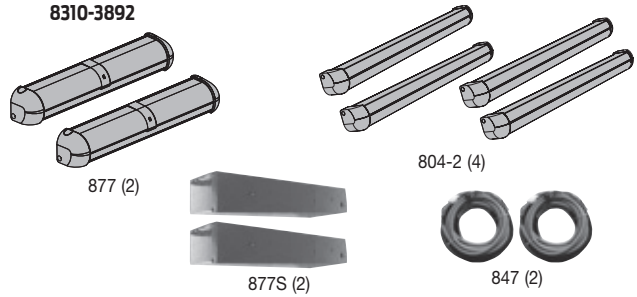

877 (2)

804-2 (4)

877S (2)

847 (2)

8310-3881

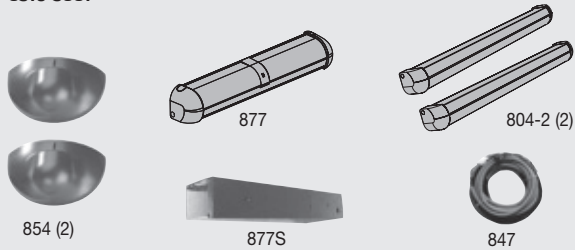

854 (2)

877

804-2 (2)

877S

847

8310-3882

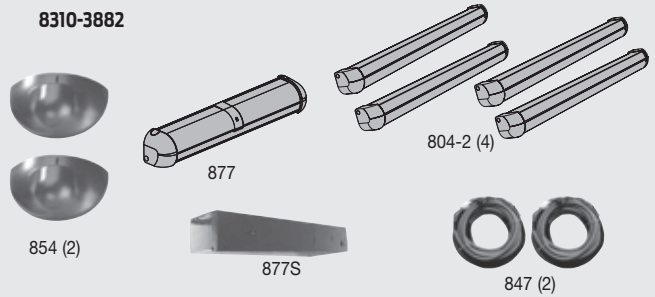

854 (2)

877

804-2 (4)

877S

847 (2)

8310-878

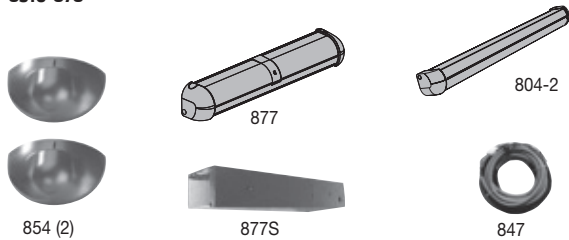

854 (2)

877

804-2

877S

847

8310-879

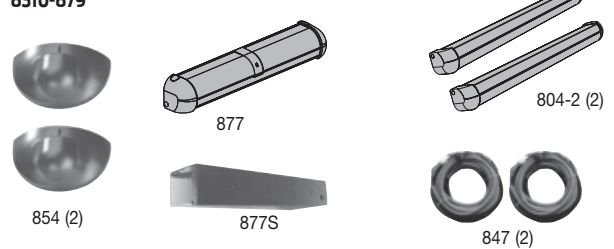

854 (2)

877

804-2 (2)

877S

847 (2)

ACTUATORS & ACCESSORIES

PRICE LIST

| ACTUATORS & ACCESSORIES | | LIST PRICE | PRODUCT DESCRIPTION |  |
|-------------------------|-------------|------------|---------------------|---|
| PRODUCT NUMBER | DESCRIPTION | | | |

8310 Series Activation/Safety Sensor Accessories

| | | | | |
|-------------|--------------------------------------|-------------|---|--|
| 8310-805 | Switch, Door Position | \$60 | Switch, Door Position, Surface Mount. Used when 8310-804-1 Surface Mount or 8310-804-2 Door Mounted Safety Sensor is installed in conjunction w/ either a 4630 or 4640 Series Automatic Operator. Disables approach side sensor when door is closed |  8310-824 |
| 8310-805C | Switch, Door Position | 60 | Switch, Door Position, Concealed. Used when 8310-804-1 Concealed or 8310-804-2 Door Mounted Safety Sensor is installed in conjunction w/ either a 4630 or 4640 Series Automatic Operator. Disables approach side sensor when door is closed |  8310-859 |
| 8310-824 | Transformer | 85 | Transformer, 24v, Hardwired. Optional accessory - Used to remotely power any 24v sensor/receiver |  8310-854ECA |
| 8310-824P | Transformer | 85 | Transformer, 24v, Plug In. Optional accessory - Used to remotely power any 24v sensor/receiver |  8310-854ERA |
| 8310-846 | Harness, Header Mount | 30 | Harness, Header Mount. Used w/ 8310-877 Header Mount Safety Sensor |  8310-854ECA |
| 8310-847 | Harness, Door Mount | 130 | Harness, Door Mount. Used w/ 8310-804-1 or 8310-804-2 Door Mount Safety Sensor |  8310-854ERA |
| 8310-854ECA | Bracket, Drop Ceiling | 215 | Bracket, Drop Ceiling. Optional bracket used w/ 8310-854 Header Mount Activation Sensor |  8310-854ERA |
| 8310-854ERA | Cover, Protective | 145 | Cover, Protective Optional cover used w/ 8310-854 Header Mount Activation Sensor |  8310-854ERA |
| 8310-859 | Remote, Handheld | 185 | Remote Control, Handheld. Optional handheld remote that can be used to program 8310-877 Header Mount Safety Sensor or 8310-854 Header Mount Motion Sensor |  8310-854ERA |
| 8310-877S | Spacer, Header Mount | 170 | Header Mount Safety Sensor Spacer. Required when 8310-804-1 or 8310-804-2 Door Mount Safety Sensors | |
| 8310-3803 | Conversion Kit, Wireless, Jamb Mount | 605 | Wireless Conversion Kit, Jamb Mount, 3v Converts standard jamb actuator to wireless version Requires 8310-819 Jamb Box - Includes 8310-865 Receiver, 8310-844J (2) Jamb Mounted Transmitter Kit | |
| 8310-3809 | Conversion Kit, Wireless, Wall Mount | 605 | Wireless Conversion Kit, Wall Mount, 9v Converts standard wall mount actuator to wireless version. Requires Surface Box & Weather Ring - Includes 8310-865 Receiver, 8310-844 (2) Wall Mount Transmitter Kit | |
| 8310-3888 | Harness, Safety Module | 40 | Harness, Safety Module, Service Part. Safety Module Harness included in 8310-3889 Safety Module & Kit | |
| 8310-3889 | Safety Module Kit | 540 | Safety Module & Kit Used w/ 7901, 7902, 7981, 7982 Control Boxes. Includes 8310-3888 Safety Module Harness, 8310-845 Time Delay Relay. Required when 8310-877 Header Mount Safety Sensor is used w/ Pneumatic Automatic Operators (2610, 4810, 4820 or 4840 Series) | |

8310 Series Activation/Safety Sensor Packages



8310-805



8310-805C



8310-824

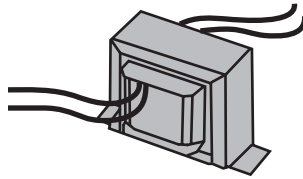

8310-824P

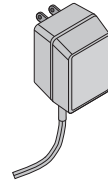

8310-846



8310-847



8310-854ECA

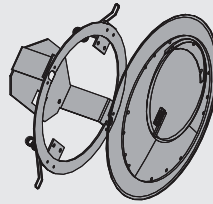

8310-854ERA

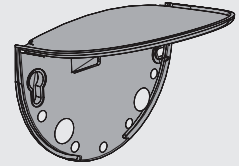

8310-859

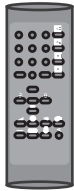

8310-8775



8310-3888



8310-3889



8310-3803

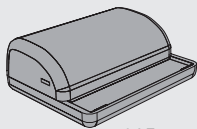

865

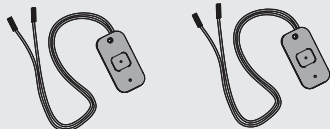

844J (2)

8310-3809

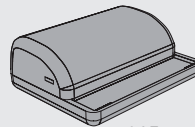

865

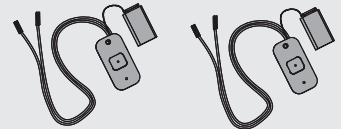

844 (2)

ACTUATORS & ACCESSORIES

PRICE LIST

| ACTUATORS & ACCESSORIES | | LIST PRICE | PRODUCT DESCRIPTION |
|-------------------------|-------------|------------|---------------------|
| PRODUCT NUMBER | DESCRIPTION | | |



8310 Series Actuators, Sensors & Accessories

| | | | |
|-----------|-----------------------------|--------------|--|
| 8310-844 | Transmitter Kit, Wall Mount | \$210 | Transmitter, Wireless, 1 Channel, Wall Mount, 9v Used to convert standard wall mount actuator to wireless. Requires 8310-865 Receiver |
| 8310-844J | Transmitter Kit, Jamb Mount | 210 | Transmitter, Wireless, 1 Channel, Jamb Mount, 3v Used to convert standard jamb mount actuator to wireless. Requires 8310-865 Receiver |
| 8310-861 | Transmitter, Handheld | 210 | Transmitter, Wireless, 1 Channel, Handheld, 9v Requires 8310-865 Receiver |
| 8310-862 | Transmitter, Handheld | 210 | Transmitter, Wireless, 2 Channel, Handheld, 9v Requires at least one 8310-865 Receiver |
| 8310-863 | Transmitter, Handheld | 210 | Transmitter, Wireless, 3 Channel, Handheld, 9v Requires at least one 8310-865 Receiver |
| 8310-864 | Transmitter, Handheld | 210 | Transmitter, Wireless, 4 Channel, Handheld, 9v Requires at least one 8310-865 Receiver |
| 8310-865 | Receiver | 220 | Receiver, Wireless, 1 Channel, Sequencing Feature Used in conjunction w/ Wireless Actuators & Transmitters |

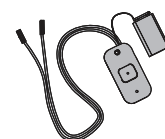

8310-844



8310-861

8310 Series Actuators, Sensors & Accessories

| | | | |
|--------------|-----------------------|--------------|---|
| 8310-866 | Post, Bollard | \$950 | 42" x 4" x 6" Bollard Post, Mounting Base, Actuator Cut-Out Requires 8310-3853WB Bollard Actuator or 8310-3853TWB Bollard Actuator. Can be used w/ 8310-853 Wall Mount Actuator, 8310-853T Wall Mount Actuator or 8310-855 Wall Mount Actuator. Includes 8310-866CAP. Available in AL or DKBRZ (please specify). |
| 8310-866FLA | Post, Bollard | 950 | 42" x 4" x 6" Bollard Post, Mounting Base, Full Length Actuator Only Requires 8310-836T Full Length Actuator or 8310-836TW Full Length Actuator. Includes 8310-866CAP. Available in AL or DKBRZ (please specify). |
| 8310-866CAP | Cap | 155 | Plastic Cap, Protective Cover, Service Part. Formed plastic cap for 8310-866 Bollard Post |
| 8310-3853WB | Actuator, Bollard | 450 | 4-3/4" Square w/ Logo, Wireless. For use w/ 8310 866 Bollard Post. Includes 8310-853 Actuator, 8310-844 Transmitter Kit. Requires 8310-865 Receiver. |
| 8310-3853TWB | Actuator, Bollard | 450 | 4-3/4" Square w/ Logo, Text, Wireless. For use w/ 8310-866 Bollard Post. Includes 8310-853T Actuator, 8310-844 Transmitter Kit. Requires 8310-865 Receiver. |
| 8310-3836T | Actuator, Full Length | 1,900 | Actuator, 36" x 6" Full Length, Logo, Text Bollard Post Available In AL or DKBRZ (Please Specify). Includes 8310-866FLA Bollard Post and 8310-836T Full Length Actuator. |
| 8310-3836TW | Actuator, Full Length | 2,075 | Actuator, 36" x 6" Full Length, Logo, Text, Wireless Includes 8310-844J. Requires 8310-865 Bollard Post Available In AL or DKBRZ (Please Specify). Includes 8310-866FLA Bollard Post, 8310-836T Full Length Actuator and 8310-844 Wireless Transmitter Kit. |
| 8310-865 | Receiver | 220 | Receiver, Wireless, 1 Channel, Sequencing Feature Used in conjunction w/ Wireless Actuators & Transmitters |

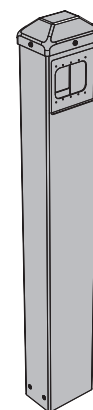

8310-866

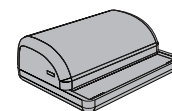

8310-865

8310 Series Actuators, Sensors & Accessories



8310-844

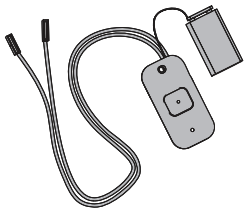

8310-844J

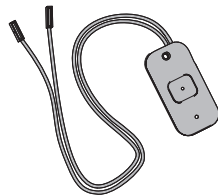

8310-865

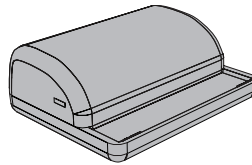

8310-866CAP

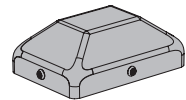

8310-3853WB

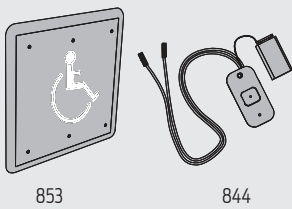

853

844

8310-866

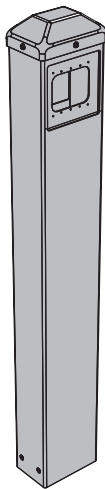

8310-866FLA

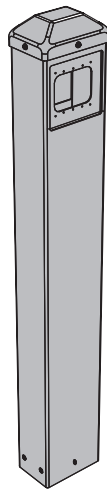

8310-3836T

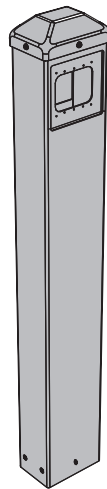

866FLA



836T

8310-3836TW

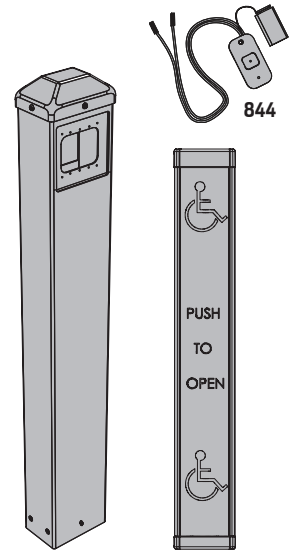

844

866FLA

836TW

8310-3853TWB

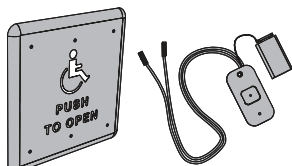

853T

844

8310-861

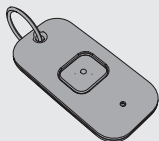

8310-862

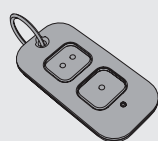

8310-863

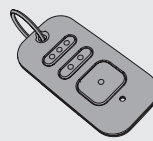

8310-864

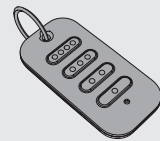

ACTUATORS & ACCESSORIES

PRICE LIST

| ACTUATORS & ACCESSORIES | | LIST PRICE | PRODUCT DESCRIPTION |
|-------------------------|-------------|------------|---------------------|
| PRODUCT NUMBER | DESCRIPTION | | |



8310 Series Accessories

| | | | |
|-----------|--------------------------|--------------|---|
| 8310-806K | Switch, Key | \$220 | Switch, Key Type, 3 Position (On/Off/Hold-Open) Optional switch used w/ Senior Swing, Benchmark, or 4630/4640 Operators with (CS) option |
| 8310-806R | Switch, Rocker | 220 | Switch, Rocker Type, 3 Position (On/Off/Hold-Open) Optional switch w/ Senior Swing or Benchmark Operators. |
| 8310-807 | Filter, Line | 220 | Line Filter, AC, 120v. Optional filter used w/ Senior Operators to reduce 'line noise'. |
| 8310-845 | Relay and Door Sequencer | 340 | Programmable Relay and Door Sequencer Used to coordinate electric locking Programmable device release for Senior Swing, also functions as door sequencer. Operator manufactured prior to 9/06. Also, is a component to the 8310-8337 Low Energy Convenience Package |

8310 Series Accessories



8310-806K



8310-806R



8310-807



8310-845



PARTS & ACCESSORIES

PRICE LIST

| PARTS & ACCESSORIES | STANDARD POWDER COAT FINISHES | PLATED FINISHES | | PARTS & ACCESSORIES | STANDARD POWDER COAT FINISHES | PLATED FINISHES | | |
|---|--|-----------------|--|---|--|-----------------|-----------------------|-------------------------|
| | AL (689) DKBRZ (695) BRASS (696) LTBRZ (691) STAT (690) BLACK (693) | | | | AL (689) DKBRZ (695) BRASS (696) LTBRZ (691) STAT (690) BLACK (693) | US26D | US 3 US 4 US 10 | US 11 US 15 US 26 |
| SEM7800 Series | | | | | | | | |
| SEM7810-E050..... Extension 1/2" | 25.00 | | | 1260-3049/PA..... Hold Open Arm w/62PA | 120.00 | | | |
| SEM7810-E075..... Extension 3/4" | 30.00 | | | 1260-3049L..... Hold Open Long Arm | 125.00 | | | |
| SEM7810-E100..... Extension 1" | 30.00 | | | 1260-3077EDA..... EDA Arm | 140.00 | | | |
| SEM7810-E200..... Extension 2" | 40.00 | | | 1260-3077EDA/G..... EDA Arm w/62G | 150.00 | | | |
| SEM7810-E400..... Extension 4" | 40.00 | | | 1260-3049EDA..... HEDA Arm | 175.00 | | | |
| SEM7810-514..... Ball Pivot/Connection Link | 30.00 | | | 1260-3049EDA/G..... HEDA Arm w/62G | 185.00 | | | |
| SEM7820-515..... Fastener Kit | 65.00 | | | 1260-3077CUSH..... CUSH Arm | 175.00 | | | |
| SEM7820-72..... Standard Cover & Base | 500.00 | | | 1260-3049CUSH..... HCUSH Arm | 235.00 | | | |
| SEM7820-825..... Door Armature | 130.00 | | | 1260-72..... Slim Cover | 15.00 | | | |
| SEM7820-516..... Magnet Core Assembly | 170.00 | | | 1260-SRT..... Screw Pack | 25.00 | | | |
| SEM7830-515..... Fastener Kit | 25.00 | | | 1260-TBSRT..... Screw Pack | 25.00 | | | |
| SEM7830-72..... Standard Cover | 100.00 | | | 1260-WMS..... Screw Pack | 25.00 | | | |
| SEM7830-268..... Surface Mount Box | 35.00 | | | 1260-TBWMS..... Screw Pack | 25.00 | | | |
| SEM7830-516..... Magnet Core Assembly | 170.00 | | | 1260-TORX..... Screw Pack | 40.00 | | | |
| SEM7830-825..... Door Armature | 130.00 | | | 1260-TBTRX..... Screw Pack | 40.00 | | | |
| SEM7840-515..... Fastener Kit | 25.00 | | | 1260-18..... Plate | 60.00 | | | |
| SEM7840-72..... Standard Cover | 100.00 | | | 1260-18PA..... Plate | 60.00 | | | |
| SEM7840-516..... Magnet Core Assembly | 170.00 | | | 1260-18QF..... Plate | 60.00 | | | |
| SEM7840-825..... Door Armature | 130.00 | | | 1260-30..... Cush Shoe Support | 20.00 | | | |
| SEM7850-515..... Fastener Kit & Bracket | 25.00 | | | 1260-37..... Hold Open Stud | 25.00 | | | |
| SEM7850-516..... Magnet Core Assembly | 170.00 | | | 1260-41..... Hold Open Nut | 5.00 | | | |
| SEM7850-72..... Standard Cover | 100.00 | | | 1260-45..... Hold Open Shoe | 20.00 | | | |
| SEM7850-828..... Door Armature | 190.00 | | | 1260-49..... Hold Open Main Arm | 65.00 | | | |
| 1250 Series | | | | | | | | |
| 1250-3071..... Std Cylinder Assy | 125.00 | | | 1260-61..... Spacer | 25.00 | | | |
| 1250-3077/PA..... Reg Arm w/62PA | 85.00 | | | 1260-62A..... Auxiliary Shoe | 40.00 | | | |
| 1250-3077/62A..... Reg Arm w/62A | 105.00 | | | 1260-62PA..... PA Shoe | 15.00 | | | |
| 1250-3077L..... Long Arm | 85.00 | | | 1260-77..... Arm & Forearm | 85.00 | | | |
| 1250-3049/PA..... Hold Open Arm w/62PA | 120.00 | | | 1260-78H..... H Head & Tube | 70.00 | | | |
| 1250-3049L..... Hold Open Long Arm | 125.00 | | | 1260-78HL..... Head & Long Tube | 75.00 | | | |
| 1250-3077EDA..... EDA Arm | 140.00 | | | 1260-79..... Rod & Shoe | 30.00 | | | |
| 1250-3049EDA..... HEDA Arm | 175.00 | | | 1260-79LR..... Long Rod & Shoe | 30.00 | | | |
| 1250-3077CUSH..... CUSH Arm | 155.00 | | | 1260-83..... Arm Screw | 3.00 | | | |
| 1250-3049CUSH..... HCUSH Arm | 235.00 | | | 1260-83H..... H Arm Screw | 3.00 | | | |
| 1250-3077SCUSH..... S Cush Arm | 235.00 | | | 1260-146..... Shaft Cover | 5.00 | | | |
| 1250-3049SCUSH..... Spring H Cush Arm | 295.00 | | | 1260-159..... Arm Screw | 3.00 | | | |
| 1250-UNIV..... Screw Pack | 25.00 | | | 1260-201..... Spacer | 5.00 | | | |
| 1250-TORX..... Screw Pack | 40.00 | | | 1260-384..... Stop | 20.00 | | | |
| 1250-TBTRX..... Screw Pack | 40.00 | | | 1260-419..... Panel Adapter | 65.00 | | | |
| 1250-72..... Slim Cover | 15.00 | | | 1260-3048..... Head & Tube Assy | 85.00 | | | |
| 1250-18..... Plate | 60.00 | | | 1260-3048L..... Head & Long Tube Assy | 85.00 | | | |
| 1250-18PA..... Plate | 60.00 | | | 1260-Flat Box..... Flat Box w/Label | 5.00 | | | |
| 1250-30..... Cush Shoe Support | 20.00 | | | 1260-Instruction Sheet..... Instruction Sheet | 3.00 | | | |
| 1250-61..... Spacer | 20.00 | | | 1260-Rebox Kit..... Box & Instruction Sheet | 5.00 | | | |
| 1250-62A..... Auxiliary Shoe | 40.00 | | | 1450 Series | | | | |
| 1250-62PA..... PA Shoe | 15.00 | | | 1450-3071..... Std Cylinder Assy | 180.00 | NA | NA | |
| 1250-146..... Shaft Cover | 5.00 | | | 1450-3071DEL..... Del Action Cylinder Assy | 225.00 | NA | NA | |
| 1250-201..... Spacer | 5.00 | | | 1450-3077/PA..... Reg Arm w/62PA | 85.00 | NA | NA | |
| 1250-419..... Panel Adapter | 60.00 | | | 1450-3077/62A..... Reg Arm w/62A | 85.00 | NA | NA | |
| 1250-3080..... Spring CUSH Block | 60.00 | | | 1450-3077L..... Long Arm | 85.00 | NA | NA | |
| 1250-Flat Box..... Flat Box w/Label | 5.00 | | | 1450-3049/PA..... H Arm w/62PA | 120.00 | NA | NA | |
| 1250-Instruction Sheet..... Instruction Sheet | 3.00 | | | 1450-3049L..... H Long Arm | 125.00 | NA | NA | |
| 1250-Rebox Kit..... Box & Instruction Sheet | 5.00 | | | 1450-3077EDA..... EDA Arm | 140.00 | NA | NA | |
| 1260 Series | | | | | | | | |
| 1261-3071..... Std Cylinder Assy | 205.00 | | | 1450-3077EDA/G..... EDA Arm w/62G | 150.00 | NA | NA | |
| 1260-3077..... Reg Arm | 85.00 | | | 1450-3049EDA..... H EDA Arm | 175.00 | NA | NA | |
| 1260-3077/PA..... Reg Arm w/62PA | 105.00 | | | 1450-3077CNS..... Cush Arm | 175.00 | NA | NA | |
| 1260-3077/62A..... Reg Arm w/62A | 90.00 | | | 1450-3049CNS..... H Cush Arm | 235.00 | NA | NA | |
| 1260-3077L..... Long Arm | 85.00 | | | 1450-3077SCNS..... S Cush Arm | 235.00 | NA | NA | |
| 1260-3049..... Hold Open Arm | 115.00 | | | 1450-3049SCNS..... Spring H Cush Arm | 295.00 | NA | NA | |
| | | | | 1450-72..... Standard Cover | 15.00 | NA | NA | |
| | | | | 1450-72FC..... Full Plastic Cover | 25.00 | NA | NA | |
| | | | | 1450-72MC..... Full Metal Cover | 45.00 | NA | NA | |

1450 Series continued on next page

PARTS & ACCESSORIES

PRICE LIST

| PARTS & ACCESSORIES | STANDARD POWDER COAT FINISHES AL (689) DKBRZ (695) BRASS (696) LTBRZ (691) STAT (690) BLACK (693) | PLATED FINISHES | | | PARTS & ACCESSORIES | STANDARD POWDER COAT FINISHES AL (689) DKBRZ (695) BRASS (696) LTBRZ (691) STAT (690) BLACK (693) | PLATED FINISHES | | | |
|--|---|-----------------|-----------------------|-------------------------|--|---|-----------------|-----------------------|-------------------------|--|
| | | US26D | US 3 US 4 US 10 | US 11 US 15 US 26 | | | US26D | US 3 US 4 US 10 | US 11 US 15 US 26 | |
| <i>1450 Series continued</i> | | | | | | | | | | |
| 1450-72ALT.....Alternate Cover | 25.00 | NA | NA | NA | 1460-49.....Hold Open Main Arm | 65.00 | | | | |
| 1450-UNIV.....Screw Pack | 25.00 | NA | NA | NA | 1460-61.....Spacer | 25.00 | 70.00 | 100.00 | | |
| 1450-TORX.....Screw Pack | 40.00 | NA | NA | NA | 1460-62A.....Auxiliary Shoe | 40.00 | 100.00 | 130.00 | | |
| 1450-TBTRX.....Screw Pack | 40.00 | NA | NA | NA | 1460-62PA.....PA Shoe | 15.00 | 90.00 | 120.00 | | |
| 1450-18.....Plate | 60.00 | NA | NA | NA | 1460-77.....Arm & Forearm | 85.00 | | | | |
| 1450-18FC.....Plate | 60.00 | NA | NA | NA | 1460-77HD.....Heavy Duty Arm & Forearm | 115.00 | | | | |
| 1450-18PA.....Plate | 60.00 | NA | NA | NA | 1460-78H.....H Head & Tube | 70.00 | | | | |
| 1450-18PAFC.....Plate | 60.00 | NA | NA | NA | 1460-78HL.....Head & Long Tube | 75.00 | | | | |
| 1450-30.....Cush Shoe Support | 20.00 | NA | NA | NA | 1460-79.....Rod & Shoe | 30.00 | 75.00 | 105.00 | | |
| 1450-31.....Cover Screw | 3.00 | NA | NA | NA | 1460-79LR.....Long Rod & Shoe | 30.00 | 75.00 | 105.00 | | |
| 1450-61.....Spacer | 20.00 | NA | NA | NA | 1460-83.....Arm Screw | 3.00 | | | | |
| 1450-62A.....Auxiliary Shoe | 40.00 | NA | NA | NA | 1460-83H.....H Arm Screw | 3.00 | | | | |
| 1450-62PA.....PA Shoe | 15.00 | NA | NA | NA | 1460-124.....Plug | 3.00 | | | | |
| 1450-146.....Shaft Cover | 5.00 | NA | NA | NA | 1460-146.....Shaft Cover | 5.00 | | | | |
| 1450-419.....Panel Adapter | 60.00 | NA | NA | NA | 1460-159.....Arm Screw | 3.00 | | | | |
| 1450-3080.....Spring Cush Block | 60.00 | NA | NA | NA | 1460-163.....Arm Insert | 3.00 | | | | |
| 1450-Flat Box.....Flat Box w/Label | 5.00 | NA | NA | NA | 1460-201.....Spacer | 5.00 | | | | |
| 1450-Instruction Sheet.....Instruction Sheet | 3.00 | NA | NA | NA | 1460-384.....Stop | 20.00 | | | | |
| 1450-Rebox Kit.....Box & Instruction Sheet | 5.00 | NA | NA | NA | 1460-419.....Panel Adapter | 65.00 | 150.00 | 180.00 | | |
| 1460 Series | | | | | | | | | | |
| 1461-3071.....Std Cylinder Assy | 265.00 | | | | 1460-3048.....Head & Tube Assy | 85.00 | 160.00 | 190.00 | | |
| 1461-3071DEL.....Del Action Cylinder Assy | 310.00 | | | | 1460-3048L.....Head & Long Tube Assy | 85.00 | 160.00 | 190.00 | | |
| 1460-3077.....Reg Arm | 85.00 | 305.00 | 335.00 | | 1460-3080.....Spring Cush Block | 60.00 | | | | |
| 1460-3077/PA.....Reg Arm w/62PA | 90.00 | 310.00 | 340.00 | | 1460-3373.....Adapter Kit | 5.00 | | | | |
| 1460-3077/62A.....Reg Arm w/62A | 105.00 | 325.00 | 355.00 | | 1460-Flat Box.....Flat Box w/Label | 5.00 | | | | |
| 1460-3077HD.....Heavy Duty Arm | 120.00 | 340.00 | 370.00 | | 1460-Instruction Sheet.....Instruction Sheet | 3.00 | | | | |
| 1460-3077HD/PA.....HD Arm w/62PA | 120.00 | 340.00 | 370.00 | | 1460-Rebox Kit.....Box & Instruction Sheet | 5.00 | | | | |
| 1460-3077HD/62A.....HD Arm w/62A | 140.00 | 360.00 | 390.00 | | 1460T Series | | | | | |
| 1460-3077HD/L.....HD Long Arm | 125.00 | 345.00 | 375.00 | | 1460T-3071.....Std Cylinder Assy | 265.00 | | | | |
| 1460-3077L.....Long Arm | 85.00 | 305.00 | 335.00 | | 1461T-3071.....Std Cylinder Assy | 265.00 | | | | |
| 1460-3049.....Hold Open Arm | 115.00 | 335.00 | 365.00 | | 1460T-3077T.....Standard Arm | 90.00 | 230.00 | 270.00 | | |
| 1460-3049/PA.....H Arm w/62PA | 120.00 | 340.00 | 370.00 | | 1460T-3038.....Standard Track | 75.00 | | | | |
| 1460-3049L.....H Long Arm | 125.00 | 345.00 | 375.00 | | 1460T-3038B.....Track w/Bumper | 80.00 | | | | |
| 1460-3077EDA.....EDA Arm | 140.00 | 360.00 | 390.00 | | 1460T-3038H.....Track w/Hold Open | 100.00 | | | | |
| 1460-3077EDA/G.....EDA Arm w/62G | 150.00 | 370.00 | 400.00 | | 1460T-3038HB.....Track w/Hold Open & Bumper | 110.00 | | | | |
| 1460-3049EDA.....H EDA Arm | 175.00 | 395.00 | 425.00 | | 1460T-72.....Standard Cover | 15.00 | | | | |
| 1460-3049EDA/G.....H EDA Arm w/62G | 185.00 | 405.00 | 435.00 | | 1460T-72DS1.....Designer Series Cover | 45.00 | 165.00 | 205.00 | | |
| 1460-3077CNS.....Cush Arm | 175.00 | 395.00 | 425.00 | | 1460T-72FC.....Full Cover | 25.00 | | | | |
| 1460-3049CNS.....H Cush Arm | 235.00 | 455.00 | 485.00 | | 1460T-SRT.....Screw Pack (incl -3034) | 50.00 | 70.00 | 85.00 | | |
| 1460-3077SCNS.....S Cush Arm | 235.00 | 455.00 | 485.00 | | 1460T-TBSRT.....Screw Pack (incl -3034) | 50.00 | 70.00 | 85.00 | | |
| 1460-3049SCNS.....Spring H Cush Arm | 295.00 | 515.00 | 545.00 | | 1460T-WMS.....Screw Pack (incl -3034) | 50.00 | 70.00 | 85.00 | | |
| 1460-72.....Standard Cover | 15.00 | | | | 1460T-TBWMS.....Screw Pack (incl -3034) | 50.00 | 70.00 | 85.00 | | |
| 1460-72DS1.....Designer Series Cover | 45.00 | 165.00 | 205.00 | | 1460T-TORX.....Screw Pack (incl -3034) | 65.00 | 85.00 | 100.00 | | |
| 1460-72FC.....Full Cover | 25.00 | | | | 1460T-TBTRX.....Screw Pack (incl -3034) | 65.00 | 85.00 | 100.00 | | |
| 1460-SRT.....Screw Pack | 25.00 | 45.00 | 60.00 | | 1460T-HSRT.....HO Screw Pack (incl -3034H) | 50.00 | 70.00 | 85.00 | | |
| 1460-TBSRT.....Screw Pack | 25.00 | 45.00 | 60.00 | | 1460T-HTBSRT.....HO Screw Pack (incl -3034H) | 50.00 | 70.00 | 85.00 | | |
| 1460-WMS.....Screw Pack | 25.00 | 45.00 | 60.00 | | 1460T-HWMS.....HO Screw Pack (incl -3034H) | 50.00 | 70.00 | 85.00 | | |
| 1460-TBWMS.....Screw Pack | 25.00 | 45.00 | 60.00 | | 1460T-HTBWSM.....HO Screw Pack (incl -3034H) | 50.00 | 70.00 | 85.00 | | |
| 1460-TORX.....Screw Pack | 40.00 | 60.00 | 75.00 | | 1460T-HTORX.....HO Screw Pack (incl -3034H) | 50.00 | 70.00 | 85.00 | | |
| 1460-TBTRX.....Screw Pack | 40.00 | 60.00 | 75.00 | | 1460T-HTBTRX.....HO Screw Pack (incl -3034H) | 50.00 | 70.00 | 85.00 | | |
| 1460-18.....Plate | 60.00 | | | | 1460T-18.....Plate | 60.00 | | | | |
| 1460-18DS.....Plate | 60.00 | 210.00 | 240.00 | | 1460T-18DS.....Plate | 60.00 | 210.00 | 240.00 | | |
| 1460-18FC.....Plate | 60.00 | | | | 1460T-18FC.....Plate | 60.00 | | | | |
| 1460-18PA.....Plate | 60.00 | | | | 1460T-18GFC.....Plate | 60.00 | | | | |
| 1460-18PADS.....Plate | 60.00 | 210.00 | 240.00 | | 1460T-18PA.....Plate | 60.00 | | | | |
| 1460-18PAFC.....Plate | 60.00 | | | | 1460T-18PADS.....Plate | 60.00 | 210.00 | 240.00 | | |
| 1460-30.....Cush Shoe Support | 20.00 | 65.00 | 95.00 | | 1460T-18PAFC.....Plate | 60.00 | | | | |
| 1460-30A.....Mounting Bracket | 7.00 | | | | 1460T-30A.....Mounting Bracket | 7.00 | | | | |
| 1460-37.....Hold Open Stud | 25.00 | | | | 1460T-73.....End Cap | 10.00 | | | | |
| 1460-41.....Hold Open Nut | 5.00 | | | | 1460T-78.....Arm & Tube | 75.00 | | | | |
| 1460-45.....Hold Open Shoe | 20.00 | | | | 1460T-82.....Rod | 60.00 | | | | |
| | | | | | 1460T-83H.....H Arm Screw | 3.00 | | | | |

1460T Series continued on next page

PARTS & ACCESSORIES

PRICE LIST

| PARTS & ACCESSORIES | STANDARD POWDER COAT FINISHES | PLATED FINISHES | | | PARTS & ACCESSORIES | STANDARD POWDER COAT FINISHES | PLATED FINISHES | | |
|--|--|-----------------|-----------------------|-------------------------|--|-------------------------------|-----------------|-----------------------|-------------------------|
| | AL (689) DKBRZ (695) BRASS (696) LTBRZ (691) STAT (690) BLACK (693) | US26D | US 3 US 4 US 10 | US 11 US 15 US 26 | | ANCLR ANDKB | US26D | US 3 US 4 US 10 | US 11 US 15 US 26 |
| <i>1460T Series continued</i> | | | | | | | | | |
| 1460T-141-1..... Plug | 3.00 | | | | 2030-3034H..... Hold Open Track Roller | 30.00 | | | |
| 1460T-141-2..... Plug | 3.00 | | | | 2030-3054..... Hold Open Clip | 30.00 | | | |
| 1460T-146..... Shaft Cover | 5.00 | | | | 2030-SPL-3034..... P-1152 Roller | 40.00 | | | |
| 1460T-159..... Arm Screw | 3.00 | | | | 2030-SPL-3038..... P-1224 Track | 75.00 | | | |
| 1460T-163..... Arm Insert | 3.00 | | | | 2030-3064H..... HO Roller and Clip | 60.00 | | | |
| 1460T-169..... Bumper Assy | 20.00 | | | | 2030-Flat Box..... Flat Box w/Label | 5.00 | | | |
| 1460T-425..... Roller Lock Screw | 5.00 | | | | 2030-Instruction Sheet..... Instruction Sheet | 3.00 | | | |
| 1460T-3034..... Track Roller | 30.00 | | | | 2030-Rebox Kit..... Box & Instruction Sheet | 5.00 | | | |
| 1460T-3034H..... Hold Open Track Roller | 30.00 | | | | | | | | |
| 1460T-3054..... Hold Open Clip | 30.00 | | | | 2210 Series | | | | |
| 1460T-Flat Box..... Flat Box w/Label | 5.00 | | | | 2213(4,5)-3071..... Std Cylinder Assy | 750.00 | 1,040.00 | 1,160.00 | |
| 1460T-Instruction Sheet..... Instruction Sheet | 3.00 | | | | 2213(4,5)-3071AVB..... AVB Cylinder Assy | 775.00 | 1,065.00 | 1,185.00 | |
| 1460T-Rebox Kit..... Box & Instruction Sheet | 5.00 | | | | 2210-3077T..... Standard Arm | 120.00 | 340.00 | 370.00 | |
| | | | | | 2210-72..... Finish Plate (11&12) | | | | |
| 2010 Series | | | | | 2210-3038..... Standard Track | 75.00 | | | |
| 2011(3,4,5,6)-3071..... Std Cylinder Assy | 485.00 | | | | 2210-TORX..... Screw Pack | 50.00 | 70.00 | 85.00 | |
| 2010-3077T..... Standard Arm | 120.00 | 340.00 | 370.00 | | 2210-11..... Finish Plate | 30.00 | 75.00 | 105.00 | |
| 2010-3038..... Standard Track | 75.00 | | | | 2210-12..... Short Finish Plate | 30.00 | 75.00 | 105.00 | |
| 2010-3038B..... Track w/Bumper | 80.00 | | | | 2210-31..... Cover Screw | 3.00 | | | |
| 2010-3038H..... Track w/Hold Open | 100.00 | | | | 2210-159..... Arm Screw | 3.00 | | | |
| 2010-3038HB..... Track w/Hold Open & Bumper | 110.00 | | | | 2210-3034..... Track Roller | 30.00 | | | |
| 2010-WMS..... Screw Pack (incl -3034) | 50.00 | 70.00 | 85.00 | | 2210-Flat Box..... Flat Box w/Label | 5.00 | | | |
| 2010-TORX..... Screw Pack (incl -3034) | 65.00 | 85.00 | 100.00 | | 2210-Instruction Sheet..... Instruction Sheet | 3.00 | | | |
| 2010-HWMS..... HO Screw Pack (incl -3034H) | 50.00 | 70.00 | 85.00 | | 2210-Rebox Kit..... Box & Instruction Sheet | 5.00 | | | |
| 2010-HTORX..... HO Screw Pack (incl -3034H) | 65.00 | 85.00 | 100.00 | | | | | | |
| 2010-11..... Finish Plate | 50.00 | 200.00 | 230.00 | | 2210DPS Series | | | | |
| 2010-31..... Cover Screw | 3.00 | | | | 2213(4,5)DPS-3071..... Std Cylinder Assy | 860.00 | 1,150.00 | 1,270.00 | |
| 2010-159..... Arm Screw | 3.00 | | | | 2213(4,5)DPS-3071AVB..... AVB Cylinder Assy | 885.00 | 1,175.00 | 1,295.00 | |
| 2010-169..... Bumper Assy | 20.00 | | | | 2210DPS-3077T..... Standard Arm | 120.00 | 340.00 | 370.00 | |
| 2010-420..... Fire Shield | 65.00 | | | | 2210DPS-72..... Finish Plate (11&12) | 55.00 | 345.00 | 465.00 | |
| 2010-425..... Roller Lock Screw | 5.00 | | | | 2210DPS-3038..... Standard Track | 75.00 | | | |
| 2010-3034..... Track Roller | 30.00 | | | | 2210DPS-TORX..... Screw Pack | 50.00 | 70.00 | 85.00 | |
| 2010-3034H..... Hold Open Track Roller | 30.00 | | | | 2210DPS-11..... Finish Plate | 30.00 | 75.00 | 105.00 | |
| 2010-3054..... Hold Open Clip | 30.00 | | | | 2210DPS-12..... Short Finish Plate | 30.00 | 75.00 | 105.00 | |
| 2010-SPL-3034..... P-1152 Roller | 40.00 | | | | 2210DPS-31..... Cover Screw | 3.00 | | | |
| 2010-SPL-3038..... P-1224 Track | 75.00 | | | | 2210DPS-159..... Arm Screw | 3.00 | | | |
| 2010-3064H..... HO Roller and Clip | 60.00 | | | | 2210DPS-493..... DPS Test Kit | 75.00 | | | |
| 2010-Flat Box..... Flat Box w/Label | 5.00 | | | | 2210DPS-3034..... Track Roller | 30.00 | | | |
| 2010-Instruction Sheet..... Instruction Sheet | 3.00 | | | | 2210DPS-3340..... Wire Harness | 75.00 | | | |
| 2010-Rebox Kit..... Box & Instruction Sheet | 5.00 | | | | 2210DPS-Flat Box..... Flat Box w/Label | 5.00 | | | |
| | | | | | 2210DPS-Instruction Sheet..... Instruction Sheet | 3.00 | | | |
| | | | | | 2210DPS-Rebox Kit..... Box & Instruction Sheet | 5.00 | | | |
| 2030 Series | | | | | 2310ME Series | | | | |
| 2031(2,3,4,5)-3071..... Std Cylinder Assy | 935.00 | 1,225.00 | 1,345.00 | | 2314ME-3071..... Std Cylinder Assy | 1,075.00 | 1,225.00 | 1,285.00 | |
| 2031(2,3,4,5)-3971..... Cylinder Only | 950.00 | | | | 2314ME-3071B80..... B80 Cylinder Assy | 1,150.00 | 1,300.00 | 1,360.00 | |
| 2030-3077T..... Standard Arm | 120.00 | 340.00 | 370.00 | | 2314ME-3071B140..... B140 Cylinder Assy | 1,150.00 | 1,300.00 | 1,360.00 | |
| 2030-3038..... Standard Track | 75.00 | | | | 2314ME-3971..... Cylinder Only | 1,075.00 | 1,225.00 | 1,285.00 | |
| 2030-3038B..... Track w/Bumper | 80.00 | | | | 2314ME-3971B80..... B80 Cylinder Only | 1,150.00 | | | |
| 2030-3038H..... Track w/Hold Open | 100.00 | | | | 2314ME-3971B140..... B140 Cylinder Only | 1,150.00 | | | |
| 2030-3038HB..... Track w/Hold Open & Bumper | 110.00 | | | | 2310ME-3077T..... Standard Arm | 115.00 | 335.00 | 365.00 | |
| 2030-WMS..... Screw Pack (incl -3034) | 50.00 | 70.00 | 85.00 | | 2310ME-72..... Finish Plate (11&12) | 55.00 | 205.00 | 265.00 | |
| 2030-TORX..... Screw Pack (incl -3034) | 65.00 | 85.00 | 100.00 | | 2310ME-3038..... Standard Track | 75.00 | | | |
| 2030-HWMS..... HO Screw Pack (incl -3034H) | 50.00 | 70.00 | 85.00 | | 2310ME-WMS..... Screw Pack (incl -3034) | 50.00 | 70.00 | 85.00 | |
| 2030-HTORX..... HO Screw Pack (incl -3034H) | 65.00 | 85.00 | 100.00 | | 2310ME-TORX..... Screw Pack (incl -3034) | 65.00 | 85.00 | 100.00 | |
| 2030-159..... Arm Screw | 3.00 | | | | 2310ME-11..... Finish Plate | 30.00 | 75.00 | 105.00 | |
| 2030-169..... Bumper Assy | 20.00 | | | | 2310ME-12..... Short Finish Plate | 30.00 | 75.00 | 105.00 | |
| 2030-416..... Wood Clip Set | 160.00 | 230.00 | 260.00 | | 2310ME-31..... Cover Screw | 3.00 | | | |
| 2030-417..... Wood Clip Set | 160.00 | 230.00 | 260.00 | | 2310ME-159..... Arm Screw | 3.00 | | | |
| 2030-420..... Fire Shield | 65.00 | | | | 2310ME-172..... Wiring Cover | 10.00 | | | |
| 2030-425..... Roller Lock Screw | 5.00 | | | | 2310ME-420..... Fire Shield | 65.00 | | | |
| 2030-3002..... Mounting/Finish Plate | 150.00 | 290.00 | | | 2310ME-425..... Roller Lock Screw | 5.00 | | | |
| 2030-3034..... Track Roller | 30.00 | | | | 2310ME-3034..... Track Roller | 30.00 | | | |

*Require length - please note when ordering

2310ME Series continued on next page

PARTS & ACCESSORIES

PRICE LIST

| PARTS & ACCESSORIES | STANDARD POWDER COAT FINISHES AL (689) DKBRZ (695) BRASS (696) LTBRZ (691) STAT (690) BLACK (693) | PLATED FINISHES | | | PARTS & ACCESSORIES | STANDARD POWDER COAT FINISHES AL (689) DKBRZ (695) BRASS (696) LTBRZ (691) STAT (690) BLACK (693) | PLATED FINISHES | | |
|--|---|-----------------|-----------------------|-------------------------|--|---|-----------------|-----------------------|-------------------------|
| | | US26D | US 3 US 4 US 10 | US 11 US 15 US 26 | | | US26D | US 3 US 4 US 10 | US 11 US 15 US 26 |
| <i>2310ME Series continued</i> | | | | | | | | | |
| 2310ME-3210.....Transformer | 75.00 | | | | 2810-572DD*.....Double Door Header Only | 483.00 | | | |
| 2310ME-3431.....Input Jumper | 75.00 | | | | 2810-572DD/S*Double Door Header Only w/Stop Prep | 483.00 | | | |
| 2310ME-3351.....ME Switch Assy | 90.00 | | | | 2810-3018.....Rear Mount Bracket | 105.00 | | | |
| 2310ME-Flat Box.....Flat Box w/Label | 5.00 | | | | 2810-3072*.....Concealing Channel | 234.00 | | | |
| 2310ME-Instruction Sheet.....Instruction Sheet | 3.00 | | | | 2810-3107.....Bottom Pivot Assembly | 168.00 | | | |
| 2310ME-Rebox Kit.....Box & Instruction Sheet | 5.00 | | | | 2810-3155.....Label Kit | 30.00 | | | |
| | | | | | 2810-3454.....Motor Gearbox | 2,375.00 | | | |
| | | | | | 2810-3462.....Controller | 1,550.00 | | | |
| 2610 Series | | | | | | | | | |
| 2613(4)-3071.....Std Cylinder Assy | 2,090.00 | 2,380.00 | 2,500.00 | | 2850 Series - (ANCLR or ANDKB only) | | | | |
| 2613(4)-3071DPS.....DPS Cylinder Assy | 2,200.00 | 2,490.00 | 2,610.00 | | 2850-3077CP.....Center Pivot Arm | 500.00 | | | |
| 2613(4)-3971.....Cylinder Only | 1,535.00 | | | | 2850-3077OP.....Offset/Butt Hung Arm | 500.00 | | | |
| 2613(4)-3971DPS.....DPS Cylinder Only | 1,645.00 | | | | 2850-3077OPCM*Offset Arm w/Track & Conc Channel | 440.00 | | | |
| 2610-3077T.....Standard Arm | 120.00 | 340.00 | 370.00 | | 2850-3572HL*.....Header Asy | 600.00 | | | |
| 2610-3038.....Standard Track | 75.00 | | | | 2850-3572HL/S*.....Header Asy w/Stop Prep | 600.00 | | | |
| 2610-WMS.....Screw Pack (incl -3034) | 50.00 | 70.00 | 85.00 | | 2850-MS-HDR.....Screw Pack Header | 25.00 | | | |
| 2610-61.....Spacer | 15.00 | | | | 2850-MS-CP.....Screw Pack Center Pivot | 25.00 | | | |
| 2610-78.....Arm & Tube | 75.00 | | | | 2850-MS-OP.....Screw Pack Offset Pivot | 25.00 | | | |
| 2610-82.....Rod | 60.00 | | | | 2850-11A.....Spindle Plate - 2 3/4" | 80.00 | | | |
| 2610-83H.....H Arm Screw | 3.00 | | | | 2850-11B.....Spindle Plate - 3 3/4" | 80.00 | | | |
| 2610-155-1.....Caution Decal | 5.00 | | | | 2850-12*.....Blank Filler Plate | 95.00 | | | |
| 2610-155-2.....Activation Decal | 5.00 | | | | 2850-78.....Arm & Tube | 210.00 | | | |
| 2610-159.....Arm Screw | 3.00 | | | | 2850-82.....Rod | 120.00 | | | |
| 2610-425.....Roller Lock Screw | 5.00 | | | | 2850-107.....Pivot Body | 70.00 | | | |
| 2610-3002.....Mounting/Finish Plate | 150.00 | 440.00 | 470.00 | | 2850-110.....Pivot Post | 55.00 | | | |
| 2610-3034.....Track Roller | 30.00 | | | | 2850-117.....Bottom Pivot Plate | 55.00 | | | |
| 2610-Flat Box.....Flat Box w/Label | 5.00 | | | | 2850-168.....Slide | 40.00 | | | |
| 2610-Instruction Sheet.....Instruction Sheet | 3.00 | | | | 2850-275.....Mounting Bracket - 2 3/4" | 110.00 | | | |
| 2610-Rebox Kit.....Box & Instruction Sheet | 5.00 | | | | 2850-334.....Header Endcaps | 45.00 | | | |
| | | | | | 2850-334-2.....End Cap | 80.00 | | | |
| | | | | | 2850-375.....Mounting Bracket - 3 3/4" | 105.00 | | | |
| | | | | | 2850-384B.....Breakaway Door Stop | 155.00 | | | |
| | | | | | 2850-384F.....Fixed Door Stop | 75.00 | | | |
| | | | | | 2850-511*.....Dress Plate Extrusion Only | 20/ft | | | |
| | | | | | 2850-518.....Cable/Parts Bag | 95.00 | | | |
| | | | | | 2850-572*.....Header Extrusion Only | 55/ft | | | |
| | | | | | 2850-572HL*.....Header Only | 483.00 | | | |
| | | | | | 2850-572DD/S*Double Door Header Asy w/Stop Prep | 483.00 | | | |
| | | | | | 2850-572DD/MPDouble Door Header w/Manual Prep | 850.00 | | | |
| | | | | | 2850-982.....Companion Cable | 70.00 | | | |
| | | | | | 2850-3018.....Rear Mount Bracket | 105.00 | | | |
| | | | | | 2810-3072MP.....Concealing Channel-Manual Prep | 234.00 | | | |
| | | | | | 2850-3107.....Bottom Pivot Assembly | 168.00 | | | |
| | | | | | 2850-3155.....Label Kit | 30.00 | | | |
| | | | | | 2850-3454.....Motor Gearbox (Std Force) | 2,375.00 | | | |
| | | | | | 2850-3462.....Controller | 1,550.00 | | | |
| | | | | | 2860 Series - (ANCLR or ANDKB only) | | | | |
| | | | | | 2860-3077CP.....Center Pivot Arm | 600.00 | | | |
| | | | | | 2860-3077OP.....Offset/Butt Hung Arm | 600.00 | | | |
| | | | | | 2860-3077OPCM*Offset Arm w/Track & Conc Channel | 440.00 | | | |
| | | | | | 2860-3572HL*.....Header Asy | 605.00 | | | |
| | | | | | 2860-3572HL/S*.....Header Asy w/Stop Prep | 605.00 | | | |
| | | | | | 2860-MS-HDR.....Screw Pack Header | 25.00 | | | |
| | | | | | 2860-MS-CP.....Screw Pack Center Pivot | 25.00 | | | |
| | | | | | 2860-MS-OP.....Screw Pack Offset Pivot | 25.00 | | | |
| | | | | | 2860-11A.....Spindle Plate - 2 3/4" | 80.00 | | | |
| | | | | | 2860-11B.....Spindle Plate - 3 3/4" | 80.00 | | | |
| | | | | | 2860-12*.....Blank Filler Plate | 95.00 | | | |
| | | | | | 2860-78.....Arm & Tube | 210.00 | | | |
| | | | | | 2860-82.....Rod | 120.00 | | | |
| | | | | | 2860-107.....Pivot Body | 70.00 | | | |
| | | | | | 2860-110.....Pivot Post | 55.00 | | | |

*Require length - please note when ordering

2860 Series continued on next page

PARTS & ACCESSORIES

PRICE LIST

| PARTS & ACCESSORIES | STANDARD POWDER COAT FINISHES | PLATED FINISHES | | | PARTS & ACCESSORIES | STANDARD POWDER COAT FINISHES | PLATED FINISHES | | |
|---------------------|--|-----------------|-----------------------|-------------------------|---------------------|--|-----------------|-----------------------|-------------------------|
| | AL (689) DKBRZ (695) BRASS (696) LTBRZ (691) STAT (690) BLACK (693) | US26D | US 3 US 4 US 10 | US 11 US 15 US 26 | | AL (689) DKBRZ (695) BRASS (696) LTBRZ (691) STAT (690) BLACK (693) | US26D | US 3 US 4 US 10 | US 11 US 15 US 26 |

2860 Series continued

| | |
|---|------------|
| 2860-117 Bottom Pivot Plate | 55.00 |
| 2860-168 Slide | 40.00 |
| 2860-275 Mounting Bracket - 2 3/4" | 110.00 |
| 2860-334 Header Endcaps | 45.00 |
| 2860-334-2 End Cap | 80.00 |
| 2860-375 Mounting Bracket - 3 3/4" | 105.00 |
| 2860-384B Breakaway Door Stop | 155.00 |
| 2860-384F Fixed Door Stop | 75.00 |
| 2860-511* Dress Plate Extrusion Only | 20.00 / ft |
| 2860-518 Cable/Parts Bag | 95.00 |
| 2860-572* Header Extrusion Only | 57.00 / ft |
| 2860-572HL* Header Only | 483.00 |
| 2860-572HL/S* Header Only w/Stop Prep | 483.00 |
| 2860-3018 Rear Mount Bracket | 105.00 |
| 2860-3107 Bottom Pivot Assembly | 168.00 |
| 2860-3155 Label Kit | 90.00 |
| 2860-3454 Motor Gearbox (Std Force) | 2,375.00 |
| 2860-3462 Control Box | 1,550.00 |

3030 Series

| | |
|--|--------|
| 3031(2,3,4)-3071 Std Cylinder Assy | 350.00 |
| 3030-3077 Reg Arm | 120.00 |
| 3030-3049 Hold Open Arm | 120.00 |
| 3030-WMS Screw Pack | 25.00 |
| 3030-TORX Screw Pack | 40.00 |
| 3030-37 Hold Open Stud | 25.00 |
| 3030-41 Hold Open Nut | 6.00 |
| 3030-48 Hold Open Forearm | 70.00 |
| 3030-49 Hold Open Main Arm | 65.00 |
| 3030-77 Arm & Forearm | 85.00 |
| 3030-79 Rod & Shoe | 30.00 |
| 3030-79H H Rod & Shoe | 30.00 |
| 3030-83 Arm Screw | 3.00 |
| 3030-83H H Arm Screw | 3.00 |
| 3030-159 Arm Screw | 3.00 |
| 3030-421 Arm Stud | 10.00 |
| 3030-Flat Box Flat Box w/Label | 4.00 |
| 3030-Instruction Sheet Instruction Sheet | 3.00 |
| 3030-Rebox Kit Box, Inst., & Screw Pk | 5.00 |

3130 Series

| | |
|--|--------|
| 3131(2,3)-3071 Std Cylinder Assy | 375.00 |
| 3130-3077T Standard Arm | 120.00 |
| 3130-3038 Standard Track | 75.00 |
| 3130-3038B Track w/Bumper | 80.00 |
| 3130-3038H Track w/Hold Open | 100.00 |
| 3130-3038HB Track w/Hold Open & Bumper | 110.00 |
| 3130-WMS Screw Pack (incl -3034) | 50.00 |
| 3130-TORX Screw Pack (incl -3034) | 65.00 |
| 3130-HWMS HO Screw Pack (incl -3034H) | 50.00 |
| 3130-HTORX HO Screw Pack (incl -3034H) | 65.00 |
| 3130-2 Channel | 10.00 |
| 3130-159 Arm Screw | 3.00 |
| 3130-169 Bumper Assy | 20.00 |
| 3130-425 Roller Lock Screw | 5.00 |
| 3130-3034 Track Roller | 30.00 |
| 3130-3034H Hold Open Track Roller | 30.00 |
| 3130-3054 Hold Open Clip | 30.00 |
| 3130-Flat Box Flat Box w/Label | 5.00 |
| 3130-Instruction Sheet Instruction Sheet | 3.00 |
| 3130-Rebox Kit Box & Instruction Sheet | 5.00 |

3130SE Series

| | |
|--|--------|
| 3133(4)SE-3071 Std Cylinder Assy | 395.00 |
| 3130SE-3077T Standard Arm | 115.00 |
| 3130SE-3077L Long Arm | 125.00 |
| 3130SE-3038 Standard Track | 405.00 |
| 3130SEL-3038SEL Long Track | 405.00 |
| 3130SE-WMS Screw Pack (incl. -81) | 25.00 |
| 3130SE-TORX Screw Pack (incl. -81) | 40.00 |
| 3130SE-59A Cover Plate | 5.00 |
| 3130SE-60 Cover Plate Screw | 3.00 |
| 3130SE-73 End Cap | 10.00 |
| 3130SE-78 Arm & Tube | 75.00 |
| 3130SE-81 Connector w/Ring | 5.00 |
| 3130SE-82 Rod | 60.00 |
| 3130SE-83H H Arm Screw | 3.00 |
| 3130SE-159 Arm Screw | 3.00 |
| 3130SE-3034SE Track Roller with Slider | 35.00 |
| 3130SE-425 Roller Lock Screw | 5.00 |
| 3130SE-3210 Transformer | 75.00 |
| 3130SE-3436 On/off Switch Assy | 75.00 |
| 3130SE-Flat Box Flat Box w/Label | 5.00 |
| 3130SE-Instruction Sheet Instruction Sheet | 3.00 |
| 3130SE-Rebox Kit Box & Instruction Sheet | 5.00 |

4000T Series

| | |
|---|--------|
| 4003(4)T-3071 Std Cylinder Assy | 350.00 |
| 4000T-3077T Standard Arm | 115.00 |
| 4000T-3038 Standard Track | 65.00 |
| 4000T-72 Standard Cover | 25.00 |
| 4000T-72MC Metal Cover | 40.00 |
| 4000T-WMS Screw Pack (incl -3034) | 50.00 |
| 4000T-TBWS Screw Pack (incl -3034) | 50.00 |
| 4000T-TORX Screw Pack (incl -3034) | 65.00 |
| 4000T-TBTRX Screw Pack (incl -3034) | 65.00 |
| 4000T-31 Cover Screw | 3.00 |
| 4000T-61 Spacer | 15.00 |
| 4000T-73 End Cap | 10.00 |
| 4000T-141-2 Plug | 3.00 |
| 4000T-159 Arm Screw | 3.00 |
| 4000T-425 Roller Lock Screw | 5.00 |
| 4000T-3034 Track Roller | 30.00 |
| 4000T-Flat Box Flat Box w/Label | 5.00 |
| 4000T-Instruction Sheet Instruction Sheet | 3.00 |
| 4000T-Rebox Kit Box & Instruction Sheet | 5.00 |

4010 Series

| | |
|---|--------|
| 4011(6)-3071 Std Cylinder Assy | 350.00 |
| 4011-3071DEL Del Act Cyl Assy | 395.00 |
| 4011(6)-3071TEL TEL Cylinder Assy | 395.00 |
| 4010-3077 Reg Arm | 120.00 |
| 4010-3049 Hold Open Arm | 175.00 |
| 4010-3049FL FL Arm | 270.00 |
| 4010-72 Standard Cover | 25.00 |
| 4010-72MC Metal Cover | 40.00 |
| 4010-SRT Screw Pack | 25.00 |
| 4010-TBSRT Screw Pack | 25.00 |
| 4010-WMS Screw Pack | 25.00 |
| 4010-TBWS Screw Pack | 25.00 |
| 4010-TORX Screw Pack | 40.00 |
| 4010-TBTRX Screw Pack | 40.00 |
| 4010-18 Plate | 60.00 |
| 4010-28 Fusible Link | 12.00 |
| 4010-31 Cover Screw | 3.00 |

4010 Series continued on next page

PARTS & ACCESSORIES

PRICE LIST

| PARTS & ACCESSORIES | STANDARD POWDER COAT FINISHES AL (689) DKBRZ (695) BRASS (696) LTBRZ (691) STAT (690) BLACK (693) | PLATED FINISHES | | | PARTS & ACCESSORIES | STANDARD POWDER COAT FINISHES AL (689) DKBRZ (695) BRASS (696) LTBRZ (691) STAT (690) BLACK (693) | PLATED FINISHES | | | |
|--|---|-----------------|-----------------------|-------------------------|-----------------------------|---|-----------------|-----------------------|-------------------------|--------|
| | | US26D | US 3 US 4 US 10 | US 11 US 15 US 26 | | | US26D | US 3 US 4 US 10 | US 11 US 15 US 26 | |
| <i>4010 Series continued</i> | | | | | | | | | | |
| 4010-37..... | Hold Open Stud | 25.00 | | | 4021(6)-3071TEL..... | TEL Cylinder Assy | 395.00 | | | |
| 4010-37FL..... | FL Hold Open Stud | 25.00 | | | 4020-3077..... | Reg Arm | 120.00 | 340.00 | | 370.00 |
| 4010-41..... | Hold Open Nut | 6.00 | | | 4020-3077L..... | Long Arm | 125.00 | 345.00 | | 375.00 |
| 4010-48..... | Hold Open Forearm | 70.00 | | | 4020-3049..... | Hold Open Arm | 175.00 | 395.00 | | 425.00 |
| 4010-49..... | Hold Open Main Arm | 65.00 | | | 4020-3049FL..... | FL Arm | 270.00 | | | |
| 4010-49FL..... | FL Main Arm & Rod | 65.00 | | | 4020-72..... | Standard Cover | 25.00 | | | |
| 4010-77..... | Arm & Forearm | 120.00 | | | 4020-72MC..... | Metal Cover | 40.00 | 215.00 | | 265.00 |
| 4010-79..... | Rod & Shoe | 30.00 | 75.00 | 105.00 | 4020-SRT..... | Screw Pack | 25.00 | 45.00 | | 60.00 |
| 4010-79H..... | H Rod & Shoe | 30.00 | 75.00 | 105.00 | 4020-TBSRT..... | Screw Pack | 25.00 | 45.00 | | 60.00 |
| 4010-79LR..... | Long Rod & Shoe | 30.00 | 75.00 | 105.00 | 4020-WMS..... | Screw Pack | 25.00 | 45.00 | | 60.00 |
| 4010-83..... | Arm Screw | 3.00 | | | 4020-TBWMS..... | Screw Pack | 25.00 | 45.00 | | 60.00 |
| 4010-83H..... | H Arm Screw | 3.00 | | | 4020-TORX..... | Screw Pack | 40.00 | 60.00 | | 75.00 |
| 4010-95..... | Arm Stud | 15.00 | | | 4020-TBTRX..... | Screw Pack | 40.00 | 60.00 | | 75.00 |
| 4010-I07 REG..... | Metal Template | 265.00 | | | 4020-18..... | Plate | 60.00 | 210.00 | | 240.00 |
| 4010-I59..... | Arm Screw | 3.00 | | | 4020-18G..... | Plate | 60.00 | 210.00 | | 240.00 |
| 4010-Flat Box..... | Flat Box w/Label | 5.00 | | | 4020-28..... | Fusible Link | 12.00 | | | |
| 4010-Instruction Sheet..... | Instruction Sheet | 3.00 | | | 4020-31..... | Cover Screw | 3.00 | | | |
| 4010-Rebox Kit..... | Box & Instruction Sheet | 5.00 | | | 4020-37..... | Hold Open Stud | 25.00 | | | |
| 4010T Series | | | | | | | | | | |
| 4010T(3,4)T-3071..... | Std Cylinder Assy | 350.00 | | | 4020-37FL..... | FL Hold Open Stud | 25.00 | | | |
| 4010T-3077T..... | Standard Arm | 115.00 | 335.00 | 365.00 | 4020-41..... | Hold Open Nut | 6.00 | | | |
| 4010T-3077DE..... | DE Arm | 150.00 | 370.00 | 400.00 | 4020-48..... | Hold Open Forearm | 70.00 | | | |
| 4010T-3038..... | Standard Track | 75.00 | | | 4020-49..... | Hold Open Main Arm | 65.00 | | | |
| 4010T-3038B..... | Track w/Bumper | 80.00 | | | 4020-49FL..... | FL Main Arm & Rod | 65.00 | | | |
| 4010T-3038H..... | Track w/Hold Open | 100.00 | | | 4020-77..... | Arm & Forearm | 120.00 | | | |
| 4010T-3038HB..... | Track w/Hold Open & Bumper | 110.00 | | | 4020-79..... | Rod & Shoe | 30.00 | 75.00 | | 105.00 |
| 4010T-72..... | Standard Cover | 25.00 | | | 4020-79H..... | H Rod & Shoe | 30.00 | 75.00 | | 105.00 |
| 4010T-72MC..... | Metal Cover | 40.00 | 215.00 | 265.00 | 4020-79LR..... | Long Rod & Shoe | 30.00 | 75.00 | | 105.00 |
| 4010T-SRT..... | Screw Pack (incl -3034) | 50.00 | 70.00 | 85.00 | 4020-83..... | Arm Screw | 3.00 | | | |
| 4010T-TBSRT..... | Screw Pack (incl -3034) | 50.00 | 70.00 | 85.00 | 4020-83H..... | H Arm Screw | 3.00 | | | |
| 4010T-WMS..... | Screw Pack (incl -3034) | 50.00 | 70.00 | 85.00 | 4020-I59..... | Arm Screw | 3.00 | | | |
| 4010T-TBWMS..... | Screw Pack (incl -3034) | 50.00 | 70.00 | 85.00 | 4020-Flat Box..... | Flat Box w/Label | 5.00 | | | |
| 4010T-TORX..... | Screw Pack (incl -3034) | 65.00 | 85.00 | 100.00 | 4020-Instruction Sheet..... | Instruction Sheet | 3.00 | | | |
| 4010T-TBTRX..... | Screw Pack (incl -3034) | 65.00 | 85.00 | 100.00 | 4020-Rebox Kit..... | Box & Instruction Sheet | 5.00 | | | |
| 4010T-HSRT..... | HO Screw Pack (incl -3034H) | 50.00 | 70.00 | 85.00 | 4020T Series | | | | | |
| 4010T-HTBSRT..... | HO Screw Pack (incl -3034H) | 50.00 | 70.00 | 85.00 | 4021(3,4)T-3071..... | Std Cylinder Assy | 350.00 | | | |
| 4010T-HWMS..... | HO Screw Pack (incl -3034H) | 50.00 | 70.00 | 85.00 | 4020T-3077T..... | Standard Arm | 115.00 | 335.00 | | 365.00 |
| 4010T-HTBWMS..... | HO Screw Pack (incl -3034H) | 50.00 | 70.00 | 85.00 | 4020T-3038..... | Standard Track | 75.00 | | | |
| 4010T-HTORX..... | HO Screw Pack (incl -3034H) | 65.00 | 85.00 | 100.00 | 4020T-3038B..... | Track w/Bumper | 80.00 | | | |
| 4010T-HTBTRX..... | HO Screw Pack (incl -3034H) | 65.00 | 85.00 | 100.00 | 4020T-3038H..... | Track w/Hold Open | 100.00 | | | |
| 4010T-18..... | Plate | 60.00 | 210.00 | 240.00 | 4020T-3038HB..... | Track w/Hold Open & Bumper | 110.00 | | | |
| 4010T-31..... | Cover Screw | 3.00 | | | 4020T-72..... | Standard Cover | 25.00 | | | |
| 4010T-73..... | End Cap | 10.00 | | | 4020T-72MC..... | Metal Cover | 40.00 | 215.00 | | 265.00 |
| 4010T-78DE..... | Main Arm & Tube | 80.00 | | | 4020T-SRT..... | Screw Pack (incl -3034) | 50.00 | 70.00 | | 85.00 |
| 4010T-82..... | Rod | 60.00 | | | 4020T-TBSRT..... | Screw Pack (incl -3034) | 50.00 | 70.00 | | 85.00 |
| 4010T-83H..... | H Arm Screw | 3.00 | | | 4020T-WMS..... | Screw Pack (incl -3034) | 50.00 | 70.00 | | 85.00 |
| 4010T-141-2..... | Plug | 3.00 | | | 4020T-TBWMS..... | Screw Pack (incl -3034) | 50.00 | 70.00 | | 85.00 |
| 4010T-159..... | Arm Screw | 3.00 | | | 4020T-TORX..... | Screw Pack (incl -3034) | 65.00 | 85.00 | | 100.00 |
| 4010T-169..... | Bumper Assy | 20.00 | | | 4020T-TBTRX..... | Screw Pack (incl -3034) | 65.00 | 85.00 | | 100.00 |
| 4010T-425..... | Roller Lock Screw | 4.00 | | | 4020T-HSRT..... | HO Screw Pack (incl -3034H) | 50.00 | 70.00 | | 85.00 |
| 4010T-3034..... | Track Roller | 30.00 | | | 4020T-HTBSRT..... | HO Screw Pack (incl -3034H) | 50.00 | 70.00 | | 85.00 |
| 4010T-3034H..... | HO Track Roller | 30.00 | | | 4020T-HWMS..... | HO Screw Pack (incl -3034H) | 50.00 | 70.00 | | 85.00 |
| 4010T-3054..... | Hold Open Clip | 30.00 | | | 4020T-HTBWMS..... | HO Screw Pack (incl -3034H) | 50.00 | 70.00 | | 85.00 |
| 4010T-3064H..... | Hold open Clip and Roller | 60.00 | | | 4020T-HTORX..... | HO Screw Pack (incl -3034H) | 65.00 | 85.00 | | 100.00 |
| 4010T-Flat Box..... | Flat Box w/Label | 5.00 | | | 4020T-HTBTRX..... | HO Screw Pack (incl -3034H) | 65.00 | 85.00 | | 100.00 |
| 4010T-Instruction Sheet..... | Instruction Sheet | 3.00 | | | 4020T-18..... | Plate | 60.00 | 210.00 | | 240.00 |
| 4010T-Rebox Kit..... | Box & Instruction Sheet | 5.00 | | | 4020T-31..... | Cover Screw | 3.00 | | | |
| 4020 Series | | | | | | | | | | |
| 4021(6)-3071..... | Std Cylinder Assy | 350.00 | | | 4020T-31..... | Cover Screw | 3.00 | | | |
| 4021-3071DEL..... | Del Act Cyl Assy | 395.00 | | | 4020T-73..... | End Cap | 10.00 | | | |
| <i>4020T Series continued on next page</i> | | | | | | | | | | |

PARTS & ACCESSORIES

PRICE LIST

| PARTS & ACCESSORIES | STANDARD POWDER COAT FINISHES <small>AL (689) DKBRZ (695) BRASS (696) LTBRZ (691) STAT (690) BLACK (693)</small> | PLATED FINISHES | | | PARTS & ACCESSORIES | STANDARD POWDER COAT FINISHES <small>AL (689) DKBRZ (695) BRASS (696) LTBRZ (691) STAT (690) BLACK (693)</small> | PLATED FINISHES | | |
|---|---|-----------------|-----------------------|-------------------------|---|---|-----------------|-----------------------|-------------------------|
| | | US26D | US 3 US 4 US 10 | US 11 US 15 US 26 | | | US26D | US 3 US 4 US 10 | US 11 US 15 US 26 |
| <i>4020T Series continued</i> | | | | | | | | | |
| 4020T-3034.....Track Roller | 30.00 | | | | 4030T-159.....Arm Screw | 3.00 | | | |
| 4020T-3034H.....Hold Open Track Roller | 30.00 | | | | 4030T-425.....Roller Lock Screw | 5.00 | | | |
| 4020T-3054.....Hold Open Clip | 30.00 | | | | 4030T-3054.....Hold Open Clip | 30.00 | | | |
| 4020T-3064H.....HO Roller and Clip | 60.00 | | | | 4030T-Flat Box.....Flat Box w/Label | 5.00 | | | |
| 4020T-Flat Box.....Flat Box w/Label | 5.00 | | | | 4030T-Instruction Sheet.....Instruction Sheet | 3.00 | | | |
| 4020T-Instruction Sheet.....Instruction Sheet | 3.00 | | | | 4030T-Rebox Kit.....Box & Instruction Sheet | 5.00 | | | |
| 4020T-Rebox Kit.....Box & Instruction Sheet | 5.00 | | | | | | | | |
| 4030 Series | | | | | | | | | |
| 4030-3071.....Std Cylinder Assy | 300.00 | | | | 4040XP Series | | | | |
| 4030-3077.....Reg Arm | 120.00 | 340.00 | 370.00 | | 4040XP-3071.....Std Cylinder Assy | 380.00 | | | |
| 4030-3077/PA.....Reg Arm w/62PA | 120.00 | 340.00 | 370.00 | | 4041-3071DEL.....Std Cylinder Assy | 425.00 | | | |
| 4030-3077/62A.....Reg Arm w/62A | 145.00 | 365.00 | 395.00 | | 4040XP-3077.....Reg Arm | 120.00 | 340.00 | 370.00 | |
| 4030-3077LD.....Light Duty Arm | 95.00 | 315.00 | 345.00 | | 4040XP-3077/PA.....Reg Arm w/62PA | 120.00 | 340.00 | 370.00 | |
| 4030-3077LD/PA.....Light Duty Arm w/PA | 110.00 | 330.00 | 360.00 | | 4040XP-3077/62A.....Reg Arm w/62A | 145.00 | 365.00 | 395.00 | |
| 4030-3077LD/62A.....Light Duty Arm w/62A | 125.00 | 345.00 | 375.00 | | 4040XP-3077L.....Long Arm | 125.00 | 345.00 | 375.00 | |
| 4030-3077L.....Long Arm | 125.00 | 345.00 | 375.00 | | 4040XP-3077XL.....XL Reg Arm | 160.00 | 380.00 | 410.00 | |
| 4030-3049.....H Arm | 175.00 | 395.00 | 425.00 | | 4040XP-3049.....Hold Open Arm | 175.00 | 395.00 | 425.00 | |
| 4030-3049/PA.....H Arm w/62PA | 185.00 | 405.00 | 435.00 | | 4040XP-3049/PA.....H Arm w/62PA | 185.00 | 405.00 | 435.00 | |
| 4030-3049/L.....H Long Arm | 185.00 | 220.00 | 250.00 | | 4040XP-3049L.....H Long Arm | 185.00 | 405.00 | 435.00 | |
| 4030-3077EDA.....EDA Arm | 160.00 | 380.00 | 410.00 | | 4040XP-3077EDA.....EDA Arm | 160.00 | 380.00 | 410.00 | |
| 4030-3049EDA.....H EDA Arm | 200.00 | 420.00 | 450.00 | | 4040XP-3077EDA/G.....EDA Arm w/62G | 165.00 | 385.00 | 415.00 | |
| 4030-3077CNS.....Cush Arm | 190.00 | 410.00 | 440.00 | | 4040XP-3049EDA.....H EDA Arm | 200.00 | 420.00 | 450.00 | |
| 4030-3049CNS.....HCush Arm | 260.00 | 480.00 | 510.00 | | 4040XP-3049EDA/G.....H EDA Arm w/62G | 210.00 | 430.00 | 460.00 | |
| 4030-3077SCNS.....SCush Arm | 265.00 | 485.00 | 515.00 | | 4040XP-3077CNS.....Cush Arm | 190.00 | 410.00 | 440.00 | |
| 4030-3049SCNS.....Spring HCush Arm | 315.00 | 535.00 | 565.00 | | 4040XP-3049CNS.....H Cush Arm | 260.00 | 480.00 | 510.00 | |
| 4030-72MC.....Metal Cover | 40.00 | 215.00 | 265.00 | | 4040XP-3077SCNS.....S Cush Arm | 265.00 | 485.00 | 515.00 | |
| 4030-WMS.....Screw Pack | 25.00 | 45.00 | 60.00 | | 4040XP-3049SCNS.....Spring H Cush Arm | 315.00 | 535.00 | 565.00 | |
| 4030-TBWMS.....Screw Pack | 25.00 | 45.00 | 60.00 | | 4040XP-72.....Standard Cover | 25.00 | | | |
| 4030-18PA.....Plate | 60.00 | 210.00 | 240.00 | | 4040XP-72MC.....Metal Cover | 40.00 | 215.00 | 265.00 | |
| 4030-18TJ.....Plate | 60.00 | 210.00 | 240.00 | | 4040XP-SRT.....Screw Pack | 25.00 | 45.00 | 60.00 | |
| 4030-30.....Cush Shoe Support | 20.00 | 65.00 | 95.00 | | 4040XP-TBSRT.....Screw Pack | 25.00 | 45.00 | 60.00 | |
| 4030-31.....Cover Screw | 3.00 | | | | 4040XP-WMS.....Screw Pack | 25.00 | 45.00 | 60.00 | |
| 4030-61.....Spacer | 25.00 | 70.00 | 100.00 | | 4040XP-TBWMS.....Screw Pack | 25.00 | 45.00 | 60.00 | |
| 4030-62A.....Auxiliary Shoe | 40.00 | 100.00 | 130.00 | | 4040XP-TORX.....Screw Pack | 40.00 | 60.00 | 75.00 | |
| 4030-62PA.....PA Shoe | 15.00 | 90.00 | 120.00 | | 4040XP-TBTRX.....Screw Pack | 40.00 | 60.00 | 75.00 | |
| 4030-77.....Arm & Forearm | 120.00 | | | | 4040XP-18.....Plate | 60.00 | 210.00 | 240.00 | |
| 4030-79.....Rod & Shoe | 30.00 | 75.00 | 105.00 | | 4040XP-18G.....Plate | 60.00 | 210.00 | 240.00 | |
| 4030-79LR.....Long Rod & Shoe | 30.00 | 75.00 | 105.00 | | 4040XP-18PA.....Plate | 60.00 | 210.00 | 240.00 | |
| 4030-83.....Arm Screw | 3.00 | | | | 4040XP-18TJ.....Plate | 60.00 | 210.00 | 240.00 | |
| 4030-83H.....H Arm Screw | 3.00 | | | | 4040XP-30.....Cush Shoe Support | 20.00 | 65.00 | 95.00 | |
| 4030-159.....Arm Screw | 3.00 | | | | 4040XP-31.....Cover Screw | 3.00 | | | |
| 4030-201.....Spacer | 5.00 | | | | 4040XP-37.....Hold Open Stud | 25.00 | | | |
| 4030-419.....Panel Adapter | 65.00 | 150.00 | 180.00 | | 4040XP-37EDA.....EDA Hold Open Stud | 25.00 | | | |
| 4030-3045.....Hold Open Shoe | 20.00 | | | | 4040XP-41.....Hold Open Nut | 6.00 | | | |
| 4030-3048.....Head & Tube Assy | 85.00 | 160.00 | 190.00 | | 4040XP-45.....Hold Open Shoe | 20.00 | | | |
| 4030-3080.....Spring Cush Block | 65.00 | | | | 4040XP-48.....Hold Open Forearm | 70.00 | | | |
| 4030-Flat Box.....Flat Box w/Label | 5.00 | | | | 4040XP-49.....Hold Open Main Arm | 65.00 | | | |
| 4030-Instruction Sheet.....Instruction Sheet | 3.00 | | | | 4040XP-54.....Snap-On Cover Clip Only | 10.00 | | | |
| 4030-Rebox Kit.....Box & Instruction Sheet | 5.00 | | | | 4040XP-58.....Spring & Screw (used with -80) | 12.00 | | | |
| | | | | | 4040XP-61.....Spacer | 25.00 | 70.00 | 100.00 | |
| | | | | | 4040XP-62A.....Auxiliary Shoe | 40.00 | 100.00 | 130.00 | |
| | | | | | 4040XP-62PA.....PA Shoe | 15.00 | 90.00 | 120.00 | |
| | | | | | 4040XP-77.....Arm & Forearm | 120.00 | | | |
| | | | | | 4040XP-78H.....H Head & Tube | 70.00 | | | |
| | | | | | 4040XP-78HL.....Head & Long Tube | 75.00 | | | |
| | | | | | 4040XP-79.....Rod & Shoe | 30.00 | 75.00 | 105.00 | |
| | | | | | 4040XP-79LR.....Long Rod & Shoe | 30.00 | 75.00 | 105.00 | |
| | | | | | 4040XP-79ELR.....XL Rod & Shoe | 65.00 | 150.00 | 180.00 | |
| | | | | | 4040XP-80.....Block (used with -58) | 50.00 | | | |
| | | | | | 4040XP-83.....Arm Screw | 3.00 | | | |
| | | | | | 4040XP-83H.....H Arm Screw | 3.00 | | | |
| | | | | | 4040XP-95.....Arm Stud | 15.00 | | | |
| | | | | | 4040XP-107CUSH.....Metal Template | 265.00 | | | |

4040XP Series continued on next page

PARTS & ACCESSORIES

PRICE LIST

| PARTS & ACCESSORIES | STANDARD POWDER COAT FINISHES AL (689) DKBRZ (695) BRASS (696) LTBRZ (691) STAT (690) BLACK (693) | PLATED FINISHES | | | PARTS & ACCESSORIES | STANDARD POWDER COAT FINISHES AL (689) DKBRZ (695) BRASS (696) LTBRZ (691) STAT (690) BLACK (693) | PLATED FINISHES | | | |
|--|---|-----------------|-----------------------|-------------------------|--|---|-----------------|-----------------------|-------------------------|--|
| | | US26D | US 3 US 4 US 10 | US 11 US 15 US 26 | | | US26D | US 3 US 4 US 10 | US 11 US 15 US 26 | |
| <i>4040XP Series continued</i> | | | | | | | | | | |
| 4040XP-107EDA.....Metal Template | 265.00 | | | | 4040SE-3077DE.....DE Arm | 165.00 | 385.00 | 415.00 | | |
| 4040XP-107REG.....Metal Template | 265.00 | | | | 4040SE-3038.....Standard Track | 405.00 | | | | |
| 4040XP-107PA.....Metal Template | 265.00 | | | | 4040SEL-3038SEL.....Long Track | 405.00 | | | | |
| 4040XP-124.....Plug | 3.00 | | | | 4040SE-72.....Standard Cover | 25.00 | | | | |
| 4040XP-159.....Arm Screw | 3.00 | | | | 4040SE-72MC.....Metal Cover | 40.00 | 215.00 | 265.00 | | |
| 4040XP-201.....Spacer | 5.00 | | | | 4040SE-WMS.....Screw Pack (inc. -81) | 25.00 | 45.00 | 60.00 | | |
| 4040XP-384.....Stop | 20.00 | | | | 4040SE-TBWMS.....Screw Pack (inc. -81) | 25.00 | 45.00 | 60.00 | | |
| 4040XP-419.....Panel Adapter | 65.00 | 150.00 | 180.00 | | 4040SE-TORX.....Screw Pack (inc. -81) | 40.00 | 60.00 | 75.00 | | |
| 4040XP-3048.....Head & Tube Assy | 85.00 | | | | 4040SE-TBTRX.....Screw Pack (inc. -81) | 40.00 | 60.00 | 75.00 | | |
| 4040XP-3048L.....Head & Long Tube Assy | 85.00 | | | | 4040SE-18.....Plate | 60.00 | 210.00 | 240.00 | | |
| 4040XP-3080Spring Cush Block Assy (incl -58 & -80) | 65.00 | | | | 4040SE-18PA.....Plate | 60.00 | 210.00 | 240.00 | | |
| 4040XP-3107T.....Metal Template Set | 1,050.00 | | | | 4040SE-31.....Cover Screw | 3.00 | | | | |
| 4040XP-Flat Box.....Flat Box w/Label | 5.00 | | | | 4040SE-59A.....Cover Plate | 5.00 | | | | |
| 4040XP-Instruction Sheet.....Instruction Sheet | 3.00 | | | | 4040SE-60.....Cover Plate Screw | 3.00 | | | | |
| 4040XP-Rebox Kit.....Box & Instruction Sheet | 5.00 | | | | 4040SE-61.....Spacer | 15.00 | | | | |
| 4040XPT Series | | | | | | | | | | |
| 4040XPT-3071.....Std Cylinder Assy | 380.00 | | | | 4040SE-73.....End Cap | 10.00 | | | | |
| 4040XPT-3077T.....Standard Arm | 115.00 | 335.00 | 365.00 | | 4040SE-78.....Arm & Tube | 75.00 | | | | |
| 4040XPT-3077DE.....DE Arm | 165.00 | 385.00 | 415.00 | | 4040SE-78DE.....Main Arm & Tube | 80.00 | | | | |
| 4040XPT-3038.....Standard Track | 75.00 | | | | 4040SE-81.....Connector w/Ring | 5.00 | | | | |
| 4040XPT-3038B.....Track w/Bumper | 80.00 | | | | 4040SE-82.....Rod | 60.00 | | | | |
| 4040XPT-3038H.....Track w/Hold Open | 100.00 | | | | 4040SE-83H.....H Arm Screw | 3.00 | | | | |
| 4040XPT-3038HB.....Track w/Hold Open & Bumper | 110.00 | | | | 4040SE-141.....Plug | 3.00 | | | | |
| 4040XPT-72.....Standard Cover | 25.00 | | | | 4040SE-141-1.....Plug | 3.00 | | | | |
| 4040XPT-72MC.....Metal Cover | 40.00 | 215.00 | 265.00 | | 4040SE-141-2.....Plug | 3.00 | | | | |
| 4040XPT-SRT.....Screw Pack (incl -3034) | 50.00 | 70.00 | 85.00 | | 4040SE-159.....Arm Screw | 3.00 | | | | |
| 4040XPT-TBSRT.....Screw Pack (incl -3034) | 50.00 | 70.00 | 85.00 | | 4040SE-425.....Roller Lock Screw | 5.00 | | | | |
| 4040XPT-WMS.....Screw Pack (incl -3034) | 50.00 | 70.00 | 85.00 | | 4040SE-3034SE.....Track Roller with slider | 35.00 | | | | |
| 4040XPT-TBWMS.....Screw Pack (incl -3034) | 50.00 | 70.00 | 85.00 | | 4040SE-3210.....SE Transformer | 75.00 | | | | |
| 4040XPT-TORX.....Screw Pack (incl -3034) | 65.00 | 85.00 | 100.00 | | 4040SE-3436.....On/Off Switch Assy | 75.00 | | | | |
| 4040XPT-TBTRX.....Screw Pack (incl -3034) | 65.00 | 85.00 | 100.00 | | 4040SE-Flat Box.....Flat Box w/Label | 5.00 | | | | |
| 4040XPT-HSRT.....HO Screw Pack (incl -3034H) | 50.00 | 70.00 | 85.00 | | 4040SE-Instruction Sheet.....Instruction Sheet | 3.00 | | | | |
| 4040XPT-HTBSRT.....HO Screw Pack (incl -3034H) | 50.00 | 70.00 | 85.00 | | 4040SE-Rebox Kit.....Box & Instruction Sheet | 5.00 | | | | |
| 4040XPT-HWMS.....HO Screw Pack (incl -3034H) | 50.00 | 70.00 | 85.00 | | 4040SEH Series | | | | | |
| 4040XPT-HTBWMS.....HO Screw Pack (incl -3034H) | 50.00 | 70.00 | 85.00 | | 4040SEH-3077SEH.....SEH Arm | 180.00 | 400.00 | 430.00 | | |
| 4040XPT-HTORX.....HO Screw Pack (incl -3034H) | 65.00 | 85.00 | 100.00 | | 4040SEH-3038.....Standard SEH Track | 405.00 | | | | |
| 4040XPT-HTBTRX.....HO Screw Pack (incl -3034H) | 65.00 | 85.00 | 100.00 | | 4040SEH-59A.....Cover Plate | 5.00 | | | | |
| 4040XPT-18.....Plate | 60.00 | 210.00 | 240.00 | | 4040SEH-78SEH.....Arm & Tube | 140.00 | 240.00 | 390.00 | | |
| 4040XPT-18TJ.....Plate | 60.00 | 210.00 | 240.00 | | 4040SEH-82SEH.....Rod | 95.00 | 235.00 | 345.00 | | |
| 4040XPT-31.....Cover Screw | 3.00 | | | | 4040SEH-83SEH.....Arm Screw | 3.00 | | | | |
| 4040XPT-54.....Snap-On Cover Clip Only | 10.00 | | | | 4040SEH-3034SEH.....Track Roller and Slider | 35.00 | | | | |
| 4040XPT-61.....Spacer | 15.00 | | | | 4050A Series | | | | | |
| 4040XPT-73.....End Cap | 10.00 | | | | 4050A-3071.....Std Cylinder Assy | 300.00 | | | | |
| 4040XPT-78DE.....Main Arm & Tube | 80.00 | | | | 4050A-3071DEL.....Del Cylinder Assy | 345.00 | | | | |
| 4040XPT-82.....Rod | 60.00 | | | | 4050A-3077/PA.....Reg Arm w/62PA | 120.00 | | | | |
| 4040XPT-83H.....H Arm Set Screw | 3.00 | | | | 4050A-3077/62A.....Reg Arm w/62A | 145.00 | | | | |
| 4040XPT-141-1.....Plug | 3.00 | | | | 4050A-3077L.....Long Arm | 125.00 | | | | |
| 4040XPT-141-2.....Plug | 3.00 | | | | 4050A-3049/PA.....H Arm w/62PA | 185.00 | | | | |
| 4040XPT-159.....Arm Screw | 3.00 | | | | 4050A-3049L.....H Long Arm | 185.00 | | | | |
| 4040XPT-169.....Bumper Assy | 20.00 | | | | 4050A-3077EDA.....EDA Arm | 160.00 | | | | |
| 4040XPT-425.....Roller Lock Screw | 5.00 | | | | 4050A-3077EDA/G.....EDA Arm w/62G | 165.00 | | | | |
| 4040XPT-3034.....Track Roller | 30.00 | | | | 4050A-3049EDA.....H EDA Arm | 200.00 | | | | |
| 4040XPT-3034H.....Hold OpenTrack Roller | 30.00 | | | | 4050A-3049EDA/G.....H EDA Arm w/62G | 210.00 | | | | |
| 4040XPT-3054.....Hold Open Clip | 30.00 | | | | 4050A-3077CNS.....Cush Arm | 190.00 | | | | |
| 4040XPT-Flat Box.....Flat Box w/Label | 5.00 | | | | 4050A-3049CNS.....H Cush Arm | 260.00 | | | | |
| 4040XPT-Instruction Sheet.....Instruction Sheet | 3.00 | | | | 4050A-3077SCNS.....S Cush Arm | 265.00 | | | | |
| 4040XPT-Rebox Kit.....Box & Instruction Sheet | 5.00 | | | | 4050A-3049SCNS.....Spring H Cush Arm | 315.00 | | | | |
| 4040SE Series | | | | | | | | | | |
| 4040SE-3071.....Std Cylinder Assy | 380.00 | | | | 4050A-D R w/pA.....Reg arm w/62PA for Delay | 120.00 | | | | |
| 4040SE-3077T.....Standard Arm | 115.00 | 335.00 | 365.00 | | 4050A-D H w/PA.....H Arm w/62PA for Delay | 185.00 | | | | |
| 4050A-62DAPA.....PA shoe for Delay 15.00 | | | | | | | | | | |

4050 Series continued on next page

PARTS & ACCESSORIES

PRICE LIST

| PARTS & ACCESSORIES | STANDARD POWDER COAT FINISHES | PLATED FINISHES | | | PARTS & ACCESSORIES | STANDARD POWDER COAT FINISHES | PLATED FINISHES | | |
|--|--|-----------------|-----------------------|-------------------------|--|--|-----------------|-----------------------|-------------------------|
| | AL (689) DKBRZ (695) BRASS (696) LTBRZ (691) STAT (690) BLACK (693) | US26D | US 3 US 4 US 10 | US 11 US 15 US 26 | | AL (689) DKBRZ (695) BRASS (696) LTBRZ (691) STAT (690) BLACK (693) | US26D | US 3 US 4 US 10 | US 11 US 15 US 26 |
| <i>4050A Series continued</i> | | | | | 4050AT-Instruction Sheet..... Instruction Sheet 3.00 | | | | |
| 4050A-31..... | Cover Screw | 3.00 | | | 4050AT-Rebox Kit..... | Box & Instruction Sheet | 5.00 | | |
| 4050A-72..... | Standard Cover | 25.00 | | | 4110 Series | | | | |
| 4050A-72ALT..... | Alternative cover | 30.00 | | | 4111(6)-3071..... | Std Cylinder Assy | 325.00 | | |
| 4050A-72MC..... | Metal Cover | 40.00 | | | 4111(6)-3071AVB..... | AVB Cylinder Assy | 350.00 | | |
| 4050A-SRT..... | Screw Pack | 25.00 | | | 4111-3071DEL..... | Delay Action Cylinder Assy | 370.00 | | |
| 4050A-TBSRT..... | Screw Pack | 25.00 | | | 4111(6)-3071TEL..... | TEL Cylinder Assy | 370.00 | | |
| 4050A-WMS..... | Screw Pack | 25.00 | | | 4110-3077EDA..... | EDA Arm | 160.00 | 380.00 | 410.00 |
| 4050A-TBWMS..... | Screw Pack | 25.00 | | | 4110-3077EDA/G..... | EDA Arm w/62G | 165.00 | 385.00 | 415.00 |
| 4050A-TORX..... | Screw Pack | 40.00 | | | 4110-3049EDA..... | H EDA Arm | 200.00 | 420.00 | 450.00 |
| 4050A-TBTRX..... | Screw Pack | 40.00 | | | 4110-3049EDA/G..... | H EDA Arm w/62G | 210.00 | 430.00 | 460.00 |
| 4050A-18..... | Plate | 60.00 | | | 4110-3077CNS..... | Cush Arm | 190.00 | 410.00 | 440.00 |
| 4050A-18G..... | Plate | 60.00 | | | 4110-3049CNS..... | H Cush Arm | 260.00 | 480.00 | 510.00 |
| 4050A-18PA..... | Plate | 60.00 | | | 4110-3077SCNS..... | S Cush Arm | 265.00 | 485.00 | 515.00 |
| 4050A-30..... | Cush Shoe Support | 25.00 | | | 4110-3049SCNS..... | Spring H Cush Arm | 315.00 | 535.00 | 565.00 |
| 4050A-61..... | Spacer | 25.00 | | | 4110-3049FL..... | FL Arm | 270.00 | | |
| 4050A-62A..... | Auxiliary Shoe | 40.00 | | | 4110-72..... | Standard Cover | 25.00 | | |
| 4050A-62PA..... | PA Shoe | 15.00 | | | 4110-72MC..... | Metal Cover | 40.00 | 215.00 | 265.00 |
| 4050A-419..... | Panel Adapter | 65.00 | | | 4110-SRT..... | Screw Pack | 25.00 | 45.00 | 60.00 |
| 4050A-3080 Spring Cush Block Assy (incl -58 & -80) | | 65.00 | | | 4110-TBSRT..... | Screw Pack | 25.00 | 45.00 | 60.00 |
| 4050A-Flat Box..... | Flat Box w/Label | 5.00 | | | 4110-WMS..... | Screw Pack | 25.00 | 45.00 | 60.00 |
| 4050A-Instruction Sheet..... | Instruction Sheet | 3.00 | | | 4110-TBWMS..... | Screw Pack | 25.00 | 45.00 | 60.00 |
| 4050A-Rebox Kit..... | Box & Instruction Sheet | 5.00 | | | 4110-TORX..... | Screw Pack | 40.00 | 60.00 | 75.00 |
| 4050AT Series | | | | | 4110-TBTRX..... | Screw Pack | 40.00 | 60.00 | 75.00 |
| 4050AT-3071..... | Std Cylinder Assy | 300.00 | | | 4110-18..... | Plate | 60.00 | 210.00 | 240.00 |
| 4050AT-3077T..... | Standard Arm | 115.00 | | | 4110-28..... | Fusible Link | 12.00 | | |
| 4050AT-3077DE..... | DE Arm | 150.00 | | | 4110-30..... | Cush Shoe Support | 25.00 | 65.00 | 95.00 |
| 4050AT-3038..... | Standard Track | 75.00 | | | 4110-31..... | Cover Screw | 3.00 | | |
| 4050AT-3038B..... | Track w/Bumper | 80.00 | | | 4110-37..... | Hold Open Stud | 25.00 | | |
| 4050AT-3038H..... | Track w/Hold Open | 100.00 | | | 4110-41..... | Hold Open Nut | 6.00 | | |
| 4050AT-3038HB..... | Track w/Hold Open & Bumper | 110.00 | | | 4110-48..... | Hold Open Forearm | 70.00 | | |
| 4050AT-72..... | Standard Cover | 25.00 | | | 4110-49FL..... | FL Main Arm & Rod | 65.00 | | |
| 4050AT-72MC..... | Metal Cover | 40.00 | | | 4110-58..... | Spring & Screw (used with -80) | 12.00 | | |
| 4050AT-SRT..... | Screw Pack (incl -3034) | 50.00 | | | 4110-61..... | Spacer | 25.00 | 70.00 | 100.00 |
| 4050AT-TBSRT..... | Screw Pack (incl -3034) | 50.00 | | | 4110-62FL..... | PA-FL Shoe | 15.00 | | |
| 4050AT-WMS..... | Screw Pack (incl -3034) | 50.00 | | | 4110-77EDA..... | Main Arm | 120.00 | | |
| 4050AT-TBWMS..... | Screw Pack (incl -3034) | 50.00 | | | 4110-80..... | Block (used with -58) | 50.00 | | |
| 4050AT-TORX..... | Screw Pack (incl -3034) | 65.00 | | | 4110-107 EDA..... | Metal Template | 265.00 | | |
| 4050AT-TBTRX..... | Screw Pack (incl -3034) | 65.00 | | | 4110-107 CUSH..... | Metal Template | 265.00 | | |
| 4050AT-HSRT..... | HO Screw Pack (incl -3034H) | 50.00 | | | 4110-3107T..... | Metal Template | 530.00 | | |
| 4050AT-HTBSRT..... | HO Screw Pack (incl -3034H) | 50.00 | | | 4110-159..... | Arm Screw | 3.00 | | |
| 4050AT-HWMS..... | HO Screw Pack (incl -3034H) | 50.00 | | | 4110-201..... | Spacer | 5.00 | | |
| 4050AT-HTBWMS..... | HO Screw Pack (incl -3034H) | 50.00 | | | 4110-3048..... | FL Forearm | | | |
| 4050AT-HTORX..... | HO Screw Pack (incl -3034H) | 65.00 | | | 4110-3080..... | Spring Cush Block (incl -58 & -80) | 65.00 | | |
| 4050AT-HTBTRX..... | HO Screw Pack (incl -3034H) | 65.00 | | | 4110-419..... | Panel Adapter | 65.00 | 150.00 | 180.00 |
| 4050AT-18..... | Plate | 60.00 | | | 4110-Flat Box..... | Flat Box w/Label | 5.00 | | |
| 4050AT-18G..... | Plate | 60.00 | | | 4110-Instruction Sheet..... | Instruction Sheet | 3.00 | | |
| 4050AT-31..... | Cover Screw | 3.00 | | | 4110-Rebox Kit..... | Box & Instruction Sheet | 5.00 | | |
| 4050AT-73..... | End Cap | 10.00 | | | 4110T Series | | | | |
| 4050AT-78DE..... | Main Arm & Tube | 80.00 | | | 4111(3,4)T-3071..... | Std Cylinder Assy | 350.00 | | |
| 4050AT-82..... | Rod | 60.00 | | | 4110T-3077T..... | Standard Arm | 115.00 | 335.00 | 365.00 |
| 4050AT-83H..... | H Arm Set Screw | 3.00 | | | 4110T-3038..... | Standard Track | 75.00 | | |
| 4050AT-141-1..... | Plug | 3.00 | | | 4110T-3038B..... | Track w/Bumper | 80.00 | | |
| 4050AT-141-2..... | Plug | 3.00 | | | 4110T-3038H..... | Track w/Hold Open | 100.00 | | |
| 4050AT-159..... | Arm Screw | 3.00 | | | 4110T-3038HB..... | Track w/Hold Open & Bumper | 110.00 | | |
| 4050AT-169..... | Bumper Assy | 20.00 | | | 4110T-72..... | Standard Cover | 25.00 | | |
| 4050AT-425..... | Roller Lock Screw | 5.00 | | | 4110T-72MC..... | Metal Cover | 40.00 | 215.00 | 265.00 |
| 4050AT-480..... | Shaft Extender | 55.00 | | | 4110T-SRT..... | Screw Pack (incl -3034) | 50.00 | 70.00 | 85.00 |
| 4050AT-3034..... | Track Roller | 30.00 | | | 4110T-TBSRT..... | Screw Pack (incl -3034) | 50.00 | 70.00 | 85.00 |
| 4050AT-3034H..... | Hold Open Track Roller | 30.00 | | | 4110T-WMS..... | Screw Pack (incl -3034) | 50.00 | 70.00 | 85.00 |
| 4050AT-3054..... | Hold Open Clip | 30.00 | | | 4110T-TBWMS..... | Screw Pack (incl -3034) | 50.00 | 70.00 | 85.00 |
| 4050AT-Flat Box..... | Flat Box w/Label | 5.00 | | | <i>4110T Series continued on next page</i> | | | | |

PARTS & ACCESSORIES

PRICE LIST

| PARTS & ACCESSORIES | STANDARD POWDER COAT FINISHES AL (689) DKBRZ (695) BRASS (696) LTBRZ (691) STAT (690) BLACK (693) | PLATED FINISHES | | | PARTS & ACCESSORIES | STANDARD POWDER COAT FINISHES AL (689) DKBRZ (695) BRASS (696) LTBRZ (691) STAT (690) BLACK (693) | PLATED FINISHES | | | |
|---|---|-----------------|-----------------------|-------------------------|---|---|-----------------|-----------------------|-------------------------|--|
| | | US26D | US 3 US 4 US 10 | US 11 US 15 US 26 | | | US26D | US 3 US 4 US 10 | US 11 US 15 US 26 | |
| <i>4110T Series continued</i> | | | | | | | | | | |
| 4110T-TORX.....Screw Pack (incl -3034) | 65.00 | 85.00 | 100.00 | | 4310HSA-3077T.....Standard Arm | 115.00 | 335.00 | 365.00 | | |
| 4110T-TBTRX.....Screw Pack (incl -3034) | 65.00 | 85.00 | 100.00 | | 4310HSA-3077DE.....DE Arm | 165.00 | 385.00 | 415.00 | | |
| 4110T-HSRT.....HO Screw Pack (incl -3034H) | 50.00 | 70.00 | 85.00 | | 4310HSA-3038.....Standard Track | 75.00 | | | | |
| 4110T-HTBSRT.....HO Screw Pack (incl -3034H) | 50.00 | 70.00 | 85.00 | | 4310HSA-72MC.....Metal Cover | 90.00 | 265.00 | 490.00 | | |
| 4110T-HWMS.....HO Screw Pack (incl -3034H) | 50.00 | 70.00 | 85.00 | | 4310HSA-WMS.....Screw Pack (incl -3034) | 50.00 | 70.00 | 85.00 | | |
| 4110T-HTBWMS.....HO Screw Pack (incl -3034H) | 50.00 | 70.00 | 85.00 | | 4310HSA-TBWMS.....Screw Pack (incl -3034) | 50.00 | 70.00 | 85.00 | | |
| 4110T-HTORX.....HO Screw Pack (incl -3034H) | 65.00 | 87.00 | 99.00 | | 4310HSA-TORX.....Screw Pack (incl -3034) | 65.00 | 85.00 | 100.00 | | |
| 4110T-HTBTRX.....HO Screw Pack (incl -3034H) | 65.00 | 87.00 | 99.00 | | 4310HSA-TBTRX.....Screw Pack (incl -3034) | 65.00 | 85.00 | 100.00 | | |
| 4110T-18.....Plate | 65.00 | 85.00 | 100.00 | | 4310HSA-18.....Plate | 190.00 | 320.00 | 350.00 | | |
| 4110T-31.....Cover Screw | 3.00 | | | | 4310HSA-31.....Cover Screw | 3.00 | | | | |
| 4110T-73.....End Cap | 10.00 | | | | 4310HSA-61.....Spacer | 15.00 | | | | |
| 4110T-141-1.....Plug | 3.00 | | | | 4310HSA-73.....End Cap | 10.00 | | | | |
| 4110T-159.....Arm Screw | 3.00 | | | | 4310HSA-83.....Arm Screw | 3.00 | | | | |
| 4110T-169.....Bumper Assy | 20.00 | | | | 4310HSA-141-2.....Plug | 3.00 | | | | |
| 4110T-425.....Roller Lock Screw | 5.00 | | | | 4310HSA-159.....Arm Screw | 3.00 | | | | |
| 4110T-3034.....Track Roller | 30.00 | | | | 4310HSA-425.....Roller Lock Screw | 5.00 | | | | |
| 4110T-3034H.....Hold Open Track Roller | 30.00 | | | | 4310HSA-3034.....Track Roller | 30.00 | | | | |
| 4110T-3054.....Hold Open Clip | 30.00 | | | | 4310HSA-3210.....Transformer | 75.00 | | | | |
| 4110T-3064H.....HO Roller and Clip | 60.00 | | | | 4310HSA-3428.....Scanner Module | 165.00 | | | | |
| 4110T-Flat Box.....Flat Box w/Label | 5.00 | | | | 4410HSA-3430.....HSA Solenoid Harness | 7.00 | | | | |
| 4110T-Instruction Sheet.....Instruction Sheet | 3.00 | | | | 4310HSA-3431.....Input Harness | 6.00 | | | | |
| 4110T-Rebox Kit.....Box & Instruction Sheet | 5.00 | | | | 4410HSA-3448.....HSA PCB Module | 25.00 | | | | |
| | | | | | 4310HSA-Flat Box.....Flat Box w/Label | 5.00 | | | | |
| | | | | | 4310HSA-Instruction Sheet.....Instruction Sheet | 3.00 | | | | |
| | | | | | 4310HSA-Rebox Kit.....Box & Instruction Sheet | 5.00 | | | | |
| 4210 Series | | | | | | | | | | |
| 4211(6)-3071.....Std Cylinder Assy | 370.00 | | | | 4310ME Series | | | | | |
| 4211(6)-3071AVB.....AVB Cylinder Assy | 395.00 | | | | 4314ME-3071.....Std Cylinder Assy | 1,015.00 | | | | |
| 4211-3071DEL.....Del Action Cylinder Assy | 415.00 | | | | 4314ME-3071B80.....B80 Cylinder Assy | 1,100.00 | | | | |
| 4210-3077EDA.....EDA Arm | 160.00 | 380.00 | 410.00 | | 4314ME-3071B140.....B140 Cylinder Assy | 1,100.00 | | | | |
| 4210-3077CNS.....Cush Arm | 190.00 | 410.00 | 440.00 | | 4314ME-3971.....Cylinder Only | 950.00 | | | | |
| 4210-3049CNS.....H Cush Arm | 260.00 | 480.00 | 510.00 | | 4314ME-3971B80.....B80 Cylinder Only | 995.00 | | | | |
| 4210-72MC.....Metal Cover | 40.00 | 215.00 | 265.00 | | 4314ME-3971B140.....B140 Cylinder Only | 995.00 | | | | |
| 4210-TORX.....Screw Pack | 50.00 | 70.00 | 85.00 | | 4310ME-3077SF.....Swing Free Arm | 115.00 | 335.00 | 365.00 | | |
| 4210-TBTRX.....Screw Pack | 50.00 | 70.00 | 85.00 | | 4310ME-3077DE.....DE Arm | 165.00 | 385.00 | 415.00 | | |
| 4210-18.....Plate | 80.00 | 280.00 | 310.00 | | 4310ME-3038.....Standard Track | 75.00 | | | | |
| 4210-18CUSH.....Plate | 80.00 | 280.00 | 310.00 | | 4310ME-72MC.....Metal Cover | 90.00 | 265.00 | 490.00 | | |
| 4210-30.....Cush Shoe Support | 20.00 | 65.00 | 95.00 | | 4310ME-WMS.....Screw Pack (incl -3034) | 50.00 | 70.00 | 85.00 | | |
| 4210-31.....Cover Screw | 3.00 | | | | 4310ME-TBWMS.....Screw Pack (incl -3034) | 50.00 | 70.00 | 85.00 | | |
| 4210-61.....Spacer | 25.00 | 70.00 | 100.00 | | 4310ME-TORX.....Screw Pack (incl -3034) | 65.00 | 85.00 | 100.00 | | |
| 4210-159.....Arm Screw | 3.00 | | | | 4310ME-TBTRX.....Screw Pack (incl -3034) | 65.00 | 85.00 | 100.00 | | |
| 4210-201.....Spacer | 5.00 | | | | 4310ME-18.....Plate | 190.00 | 320.00 | 350.00 | | |
| 4210-419.....Panel Adapter | 65.00 | 150.00 | 180.00 | | 4310ME-31.....Cover Screw | 3.00 | | | | |
| 4210-Flat Box.....Flat Box w/Label | 5.00 | | | | 4310ME-61.....Spacer | 15.00 | | | | |
| 4210-Instruction Sheet.....Instruction Sheet | 3.00 | | | | 4310ME-73.....End Cap | 10.00 | | | | |
| 4210-Rebox Kit.....Box & Instruction Sheet | 5.00 | | | | 4310ME-83.....Arm Screw | 3.00 | | | | |
| | | | | | 4310ME-141-2.....Plug | 3.00 | | | | |
| | | | | | 4310ME-159.....Arm Screw | 3.00 | | | | |
| | | | | | 4310ME-425.....Roller Lock Screw | 5.00 | | | | |
| | | | | | 4310ME-3034.....Track Roller | 30.00 | | | | |
| | | | | | 4310ME-3210.....Transformer | 75.00 | | | | |
| | | | | | 4310ME-3351.....ME Switch Assy | 165.00 | | | | |
| | | | | | 4310ME-3354.....ME Wire Harness | 15.00 | | | | |
| | | | | | 4310ME-3431.....Input Harness | 6.00 | | | | |
| | | | | | 4310ME-Flat Box.....Flat Box w/Label | 5.00 | | | | |
| | | | | | 4310ME-Instruction Sheet.....Instruction Sheet | 3.00 | | | | |
| | | | | | 4310ME-Rebox Kit.....Box & Instruction Sheet | 5.00 | | | | |
| | | | | | | | | | | |
| | | | | | 4410HSA Series | | | | | |
| 4311HSA-3071.....Std Cylinder Assy | 1,100.00 | | | | 4414HSA-3071.....Std Cylinder Assy | 1,100.00 | | | | |
| 4311HSA-3971.....Cylinder Only | 995.00 | | | | 4414HSA-3071/18G.....Std Cyl. Assy w/18G | 1,100.00 | | | | |
| | | | | | 4414HSA-3971.....Cylinder Only | 950.00 | | | | |
| | | | | | 4410HSA-3077.....Reg Arm | 120.00 | 340.00 | 370.00 | | |
| | | | | | 4410HSA-3077L.....Long Arm | 125.00 | 345.00 | 375.00 | | |
| | | | | | 4410HSA-72MC.....Metal Cover | 90.00 | 265.00 | 490.00 | | |
| | | | | | 4410HSA-WMS.....Screw Pack | 25.00 | 45.00 | 60.00 | | |

4410HSA Series continued on next page

PARTS & ACCESSORIES

PRICE LIST

| PARTS & ACCESSORIES | STANDARD POWDER COAT FINISHES AL (689) DKBRZ (695) BRASS (696) LTBRZ (691) STAT (690) BLACK (693) | PLATED FINISHES | | | PARTS & ACCESSORIES | STANDARD POWDER COAT FINISHES ANCLR ANDKB | PLATED FINISHES | | |
|---|---|-----------------|-----------------------|-------------------------|---|---|-----------------|-----------------------|-------------------------|
| | | US26D | US 3 US 4 US 10 | US 11 US 15 US 26 | | | US26D | US 3 US 4 US 10 | US 11 US 15 US 26 |
| <i>4410HSA Series continued</i> | | | | | | | | | |
| 4410HSA-TBWMS.....Screw Pack | 25.00 | 45.00 | | 60.00 | 4510-Flat Box.....Flat Box w/Label | 5.00 | | | |
| 4410HSA-TORX.....Screw Pack | 40.00 | 60.00 | | 75.00 | 4510-Instruction Sheet.....Instruction Sheet | 3.00 | | | |
| 4410HSA-TBTRX.....Screw Pack | 40.00 | 60.00 | | 75.00 | 4510-Rebox Kit.....Box & Instruction Sheet | 5.00 | | | |
| 4410HSA-18.....Plate | 190.00 | 320.00 | | 350.00 | 4510T Series | | | | |
| 4410HSA-18G.....Mounting Plate | 190.00 | 320.00 | | 350.00 | 4511(3,4)T-3071.....Std Cylinder Assy | 370.00 | | | |
| 4410HSA-31.....Cover Screw | 3.00 | | | | 4511(3,4)T-3071AVB.....AVB Cylinder Assy | 395.00 | | | |
| 4410HSA-77.....Arm & Forearm | 120.00 | | | | 4510T-3077T.....Standard Arm | 120.00 | 340.00 | | 370.00 |
| 4410HSA-77L.....Long Arm & Forearm | 120.00 | | | | 4510T-3038.....Standard Track | 150.00 | | | |
| 4410HSA-79.....Rod & Shoe | 30.00 | 75.00 | | 105.00 | 4510T-72MC.....Metal Cover | 40.00 | 215.00 | | 265.00 |
| 4410HSA-79L.....Long Rod & Shoe | 45.00 | 105.00 | | 135.00 | 4510T-TORX.....Screw Pack | 50.00 | 70.00 | | 85.00 |
| 4410HSA-83H.....H Arm Screw | 3.00 | | | | 4510T-TBTRX.....Screw Pack | 50.00 | 70.00 | | 85.00 |
| 4410HSA-159.....Arm Screw | 3.00 | | | | 4510T-18.....Plate | 80.00 | 280.00 | | 310.00 |
| 4410HSA-3210.....Transformer | 75.00 | | | | 4510T-31.....Cover Screw | 3.00 | | | |
| 4410HSA-3428.....Scanner Module | 165.00 | | | | 4510T-159.....Arm Screw | 3.00 | | | |
| 4410HSA-3430.....HSA Solenoid Harness | 7.00 | | | | 4510T-3034.....Track Roller | 30.00 | | | |
| 4410HSA-3431.....Input Harness | 6.00 | | | | 4510T-Flat Box.....Flat Box w/Label | 5.00 | | | |
| 4410HSA-3448.....HSA PCB Module | 25.00 | | | | 4510T-Instruction Sheet.....Instruction Sheet | 3.00 | | | |
| 4410HSA-Flat Box.....Flat Box w/Label | 5.00 | | | | 4510T-Rebox Kit.....Box & Instruction Sheet | 5.00 | | | |
| 4410HSA-Instruction Sheet.....Instruction Sheet | 3.00 | | | | 4630 Series | | | | |
| 4410HSA-Rebox Kit.....Box & Instruction Sheet | 5.00 | | | | 4631-3071.....Std Cylinder Assy | 5,450.00 | | | |
| 4410ME Series | | | | | | | | | |
| 4414ME-3071.....Std Cylinder Assy | 1,015.00 | | | | 4631-3071CS.....Cyl Assy w/Conc I/O Switch | 5,450.00 | | | |
| 4414ME-3071/18G.....Std Cyl. Assy w/18G | 1,015.00 | | | | 4631-3971.....Cylinder Only | 1,920.00 | | | |
| 4414ME-3071B80.....B80 Cylinder Assy | 1,100.00 | | | | 4630-3077T.....Standard Arm | 120.00 | 340.00 | | 370.00 |
| 4414ME-3071B80G.....B80 Cyl. Assy w/18G | 1,100.00 | | | | 4630-3038.....Standard Track | 75.00 | | | |
| 4414ME-3071B140.....B140 Cylinder Assy | 1,100.00 | | | | 4630-72MC.....Metal Cover | 185.00 | 360.00 | | 585.00 |
| 4414ME-3071B140G.....B140 Cyl. Assy w/18G | 1,100.00 | | | | 4630-WMS.....Screw Pack (incl -3034) | 75.00 | 95.00 | | 110.00 |
| 4414ME-3971.....Cylinder Only | 950.00 | | | | 4630-TBWMS.....Screw Pack (incl -3034) | 75.00 | 95.00 | | 110.00 |
| 4414ME-3971B80.....B80 Cylinder Only | 950.00 | | | | 4630-TORX.....Screw Pack (incl -3034) | 90.00 | 110.00 | | 125.00 |
| 4414ME-3971B140.....B140 Cylinder Only | 950.00 | | | | 4630-TBTRX.....Screw Pack (incl -3034) | 90.00 | 110.00 | | 125.00 |
| 4410ME-3077.....Reg Arm | 120.00 | 340.00 | | 370.00 | 4630-31.....Cover Screw | 3.00 | | | |
| 4410ME-3077L.....Long Arm | 125.00 | 345.00 | | 375.00 | 4630-61.....Spacer | 15.00 | | | |
| 4410ME-72MC.....Metal Cover | 90.00 | 265.00 | | 490.00 | 4630-73.....End Cap | 10.00 | | | |
| 4410ME-WMS.....Screw Pack | 25.00 | 45.00 | | 60.00 | 4630-78.....Arm & Tube | 75.00 | 175.00 | | |
| 4410ME-TBWMS.....Screw Pack | 25.00 | 45.00 | | 60.00 | 4630-82.....Rod | 60.00 | 120.00 | | |
| 4410ME-TORX.....Screw Pack | 40.00 | 60.00 | | 75.00 | 4630-83H.....H Arm Screw | 3.00 | | | |
| 4410ME-TBTRX.....Screw Pack | 40.00 | 60.00 | | 75.00 | 4630-141-2.....Plug | 3.00 | | | |
| 4410ME-18.....Plate | 190.00 | 320.00 | | 350.00 | 4630-155-1.....Caution Decal | 5.00 | | | |
| 4410ME-18G.....Mounting Plate | 190.00 | 320.00 | | 350.00 | 4630-155-2.....Activation Decal | 5.00 | | | |
| 4410ME-31.....Cover Screw | 3.00 | | | | 4630-159.....Arm Screw | 3.00 | | | |
| 4410ME-77.....Arm & Forearm | 120.00 | 260.00 | | 290.00 | 4630-334.....End Cap | 40.00 | | | |
| 4410ME-77L.....Long Arm & Forearm | 120.00 | 260.00 | | 290.00 | 4630-334-2.....End Cap, Plain | 40.00 | | | |
| 4410ME-79.....Rod & Shoe | 30.00 | 75.00 | | 105.00 | 4630-334CS.....End Cap, Concealed Switch | 40.00 | | | |
| 4410ME-79L.....ME Long Rod | 45.00 | 105.00 | | 135.00 | 4630-425.....Roller Lock Screw | 5.00 | | | |
| 4410ME-83H.....H Arm Screw | 3.00 | | | | 4630-480.....Shaft Extension | 55.00 | | | |
| 4410ME-159.....Arm Screw | 3.00 | | | | 4630-3018.....Mounting Plate Assy | 3,200.00 | | | |
| 4410ME-3210.....Transformer | 75.00 | | | | 4630-3034.....Track Roller | 30.00 | | | |
| 4410ME-3351.....ME Switch Assy | 165.00 | | | | 4630-3179-1.....On/Off Switch Assy | 50.00 | | | |
| 4410ME-3354.....ME Wire Harness | 15.00 | | | | 4630-3179-2.....Hold Open Switch Assy | 50.00 | | | |
| 4410ME-3431.....Input Harness | 6.00 | | | | 4630-3180.....I/O Board Assy | 335.00 | | | |
| 4410ME-Flat Box.....Flat Box w/Label | 5.00 | | | | 4630-3454.....Motor/Clutch Assy | 1,590.00 | | | |
| 4410ME-Instruction Sheet.....Instruction Sheet | 3.00 | | | | 4630-3462.....Controller Assy | 1,810.00 | | | |
| 4410ME-Rebox Kit.....Box & Instruction Sheet | 5.00 | | | | 4630-3498-1.....Ribbon Cable Connector | 25.00 | | | |
| 4510 Series | | | | | | | | | |
| 4511(6)-3071.....Std Cylinder Assy | 370.00 | | | | 4630-3498-2.....A/C Power Cable | 50.00 | | | |
| 4511(6)-3071AVB.....AVB Cylinder Assy | 395.00 | | | | 4630-Flat Box.....Flat Box w/Label | 5.00 | | | |
| 4511-3071DEL.....Del Action Cylinder Assy | 415.00 | | | | 4630-Instruction Sheet.....Instruction Sheet | 3.00 | | | |
| 4510-3077EDA.....EDA Arm | 160.00 | 380.00 | | 410.00 | 4630-Rebox Kit.....Box & Instruction Sheet | 5.00 | | | |
| 4510-72MC.....Metal Cover | 40.00 | 215.00 | | 265.00 | 4640 Series | | | | |
| 4510-TORX.....Screw Pack | 50.00 | 70.00 | | 85.00 | 4642-3071.....Std Cylinder Assy | 5,450.00 | | | |
| 4510-TBTRX.....Screw Pack | 50.00 | 70.00 | | 85.00 | 4642-3071CS.....Cyl Assy w/Conc I/O Switch | 5,450.00 | | | |
| 4510-18.....Plate | 80.00 | 280.00 | | 310.00 | 4642-3971.....Cylinder Only | 1,920.00 | | | |
| 4510-31.....Cover Screw | 3.00 | | | | 4640-3077.....Reg Arm | 120.00 | 340.00 | | 370.00 |
| 4510-159.....Arm Screw | 3.00 | | | | 4640-3077L.....Long Arm | 125.00 | 345.00 | | 375.00 |
| | | | | | 4640-72MC.....Metal Cover | 185.00 | 360.00 | | 585.00 |

4640 Series continued on next page

PARTS & ACCESSORIES

PRICE LIST

| PARTS & ACCESSORIES | STANDARD POWDER COAT FINISHES ANCLR ANDKB | PLATED FINISHES | | | PARTS & ACCESSORIES | STANDARD POWDER COAT FINISHES ANCLR ANDKB | PLATED FINISHES | | |
|--|---|-----------------|-----------------------|--|---------------------|---|-----------------|-----------------------|-------------------------|
| | | US26D | US 3 US 4 US 10 | US 11 US 15 US 26 | | | US26D | US 3 US 4 US 10 | US 11 US 15 US 26 |
| <i>4640 Series continued</i> | | | | | | | | | |
| 4640-WMS.....Screw Pack | 50.00 | 70.00 | 85.00 | 4820-18.....Plate | 250.00 | 380.00 | | | |
| 4640-TBWS.....Screw Pack | 50.00 | 70.00 | 85.00 | 4820-186.....Plate | 250.00 | 380.00 | | | |
| 4640-TORX.....Screw Pack | 65.00 | 85.00 | 100.00 | 4820-31.....Cover Screw | 3.00 | | | | |
| 4640-TBTRX.....Screw Pack | 65.00 | 85.00 | 100.00 | 4820-31L.....Long Cover Screw | 3.00 | | | | |
| 4640-31.....Cover Screw | 3.00 | | | 4820-77.....Arm & Forearm | 120.00 | 260.00 | | | |
| 4640-77.....Arm & Forearm | 120.00 | 260.00 | | 4820-79.....Rod & Shoe | 30.00 | 75.00 | | | |
| 4640-79.....Rod & Shoe | 30.00 | 75.00 | | 4820-79LR.....Long Rod & Shoe | 55.00 | 115.00 | | | |
| 4640-79LR.....Long Rod & Shoe | 55.00 | 115.00 | | 4820-83.....Arm Screw | 3.00 | | | | |
| 4640-83.....Arm Screw | 3.00 | | | 4820-155-1.....Caution Decal | 5.00 | | | | |
| 4640-155-1.....Caution Decal | 5.00 | | | 4820-155-2.....Activation Decal | 5.00 | | | | |
| 4640-155-2.....Activation Decal | 5.00 | | | 4820-159.....Arm Screw | 3.00 | | | | |
| 4640-159.....Arm Screw | 3.00 | | | 4820-163.....Cover Insert | 5.00 | | | | |
| 4640-334.....End Cap | 40.00 | | | 4820-182.....Stand Off | 15.00 | | | | |
| 4640-334-2.....End Cap, Plain | 40.00 | | | 4820-334.....Cover End Cap | 12.00 | | | | |
| 4640-334CS.....End Cap, Concealed Switch | 40.00 | | | 4820-3377.....DPS Conversion Kit | 405.00 | | | | |
| 4640-480.....Shaft Extension | 55.00 | | | 4820-Flat Box.....Flat Box w/Label | 5.00 | | | | |
| 4640-3018.....Mounting Plate Assy | 3,200.00 | | | 4820-Instruction Sheet.....Instruction Sheet | 3.00 | | | | |
| 4640-3179-1.....On/Off Switch Assy | 50.00 | | | 4820-Rebox Kit.....Box & Instruction Sheet | 5.00 | | | | |
| 4640-3179-2.....Hold Open Switch Assy | 50.00 | | | | | | | | |
| 4640-3180.....I/O Board Assy | 335.00 | | | 4840 Series | | | | | |
| 4640-3454.....Motor/Clutch Assy | 1,590.00 | | | 4841-3071.....Std Cylinder Assy | 1,825.00 | | | | |
| 4640-3462.....Controller Assy | 1,810.00 | | | 4841-3971.....Cylinder Only | 1,750.00 | | | | |
| 4640-3498-1.....Ribbon Cable Connector | 25.00 | | | 4840-3077EDA.....EDA Arm | 160.00 | 380.00 | | 410.00 | |
| 4640-3498-2.....A/C Power Cable | 50.00 | | | 4840-3077CNS.....Cush Arm | 190.00 | 410.00 | | 440.00 | |
| 4640-Flat Box.....Flat Box w/Label | 5.00 | | | 4840-3077SCNS.....Spring Cush Arm | 265.00 | 485.00 | | 515.00 | |
| 4640-Instruction Sheet.....Instruction Sheet | 3.00 | | | 4840-72MC.....Metal Cover | 225.00 | 400.00 | | 625.00 | |
| 4640-Rebox Kit.....Box & Instruction Sheet | 5.00 | | | 4840-WMS.....Screw Pack | 25.00 | 45.00 | | 60.00 | |
| | | | | 4840-TBWS.....Screw Pack | 25.00 | 45.00 | | 60.00 | |
| | | | | 4840-30.....Cush Shoe Support | 25.00 | 45.00 | | 60.00 | |
| | | | | 4840-31.....Cover Screw | 3.00 | | | | |
| | | | | 4840-31L.....Long Cover Screw | 3.00 | | | | |
| | | | | 4840-61.....Spacer | 25.00 | 70.00 | | | |
| | | | | 4840-124.....Plug | 3.00 | | | | |
| | | | | 4840-155-1.....Caution Decal | 5.00 | | | | |
| | | | | 4840-155-2.....Activation Decal | 5.00 | | | | |
| | | | | 4840-159.....Arm Screw | 3.00 | | | | |
| | | | | 4840-163.....Cover Insert | 5.00 | | | | |
| | | | | 4840-182.....Stand Off | 15.00 | | | | |
| | | | | 4840-201.....Spacer | 5.00 | | | | |
| | | | | 4840-334.....Cover End Cap | 12.00 | | | | |
| | | | | 4840-419.....Panel Adapter | 65.00 | 150.00 | | | |
| | | | | 4840-459.....Door Loop Kit | 140.00 | | | | |
| | | | | 4840-460.....Pneumatic Hinge | 510.00 | | | | |
| | | | | 4840-3080.....Spring Cush Block | 65.00 | | | | |
| | | | | 4840-Flat Box.....Flat Box w/Label | 5.00 | | | | |
| | | | | 4840-Instruction Sheet.....Instruction Sheet | 3.00 | | | | |
| | | | | 4840-Rebox Kit.....Box & Instruction Sheet | 5.00 | | | | |
| | | | | | | | | | |
| | | | | 5010 Series | | | | | |
| | | | | 5011(2,3,4,5,6)-3071.....Std Cylinder Assy | 510.00 | 800.00 | | 920.00 | |
| | | | | 5011(2,3,4,5)-3071DEL.....Del Act Cyl Assy | 555.00 | 845.00 | | 965.00 | |
| | | | | 5010-3077.....Reg Arm | 120.00 | 340.00 | | 370.00 | |
| | | | | 5010-3049.....Hold Open Arm | 120.00 | 340.00 | | 370.00 | |
| | | | | 5010-WMS.....Screw Pack | 25.00 | 45.00 | | 60.00 | |
| | | | | 5010-TORX.....Screw Pack | 40.00 | 60.00 | | 75.00 | |
| | | | | 5010-11.....Finish Plate | 50.00 | 200.00 | | | |
| | | | | 5010-NIDA.....DA Finish Plate | 50.00 | 200.00 | | | |
| | | | | 5010-31.....Cover Screw | 3.00 | | | | |
| | | | | 5010-37.....Hold Open Stud | 25.00 | | | | |
| | | | | 5010-41.....Hold Open Nut | 6.00 | | | | |
| | | | | 5010-45.....Hold Open Shoe | 25.00 | | | | |
| | | | | 5010-48.....Hold Open Forearm | 70.00 | | | | |
| | | | | 5010-49.....Hold Open Main Arm | 65.00 | | | | |
| | | | | 5010-77.....Arm & Forearm | 120.00 | | | | |
| | | | | 5010-79.....Rod & Shoe | 30.00 | 75.00 | | | |
| | | | | 5010-79H.....H Rod & Shoe | 30.00 | 75.00 | | | |
| | | | | 5010-83.....Arm Screw | 3.00 | | | | |
| | | | | <i>5010 Series continued on next page</i> | | | | | |

PARTS & ACCESSORIES

PRICE LIST

| PARTS & ACCESSORIES | STANDARD POWDER COAT FINISHES <i>AL (689) DKBRZ (695) BRASS (696) LTBRZ (691) STAT (690) BLACK (693)</i> | PLATED FINISHES | | | PARTS & ACCESSORIES | STANDARD POWDER COAT FINISHES <i>ANCLR ANDKB</i> | PLATED FINISHES | |
|--|---|-----------------|-----------------------|-------------------------|--|---|-----------------|--|
| | | US26D | US 3 US 4 US 10 | US 11 US 15 US 26 | | | | |
| <i>5010 Series continued</i> | | | | | | | | |
| 5010-83H.....H Arm Screw | 3.00 | | | | 9130-3018.....Mounting Bracket | 150.00 | | |
| 5010-95.....Arm Stud | 15.00 | | | | 9130-3155.....Label Kit | 30.00 | | |
| 5010-159.....Arm Screw | 3.00 | | | | 9130-3034.....Track Roller | 35.00 | | |
| 5010-3002.....Mounting/Finish Plate | 70.00 | | | | 9130-3351-1.....Switch Bracket 29" | 68.00 | | |
| 5010-Flat Box.....Flat Box w/Label | 5.00 | | | | 9130-3351-2.....Switch Bracket 41" | 68.00 | | |
| 5010-Instruction Sheet.....Instruction Sheet | 3.00 | | | | 9130-3351-3.....Switch Bracket 51" | 68.00 | | |
| 5010-Rebox Kit.....Box & Instruction Sheet | 5.00 | | | | 9130-3454.....Motor Gearbox Assembly | 1,898.00 | | |
| 5030 Series | | | | | | | | |
| 5031(3,4,5,6)-3071.....Std Cylinder Assy | 935.00 | 1,225.00 | | 1,345.00 | 9130-3454S.....Motor Gearbox Assembly w/Switch | 1,898.00 | | |
| 5031(3,4,5,6)-3971.....Cylinder Only | 865.00 | | | | 9130-3462SC.....Standard Control Box | 1,305.00 | | |
| 5030-3077.....Reg Arm | 120.00 | 340.00 | | 370.00 | 9130-3498-2A.....A/C Power Cable - 29" | 40.00 | | |
| 5030-3049.....Hold Open Arm | 120.00 | 340.00 | | 370.00 | 9130-3498-2B.....A/C Power Cable - 42" | 40.00 | | |
| 5030-WMS.....Screw Pack | 25.00 | 45.00 | | 60.00 | 9130-3498-2C.....A/C Power Cable - 52" | 40.00 | | |
| 5030-TORX.....Screw Pack | 40.00 | 60.00 | | 75.00 | 9130-Rebox Kit.....Box & Instruction Sheet | 5.00 | | |
| 5030-37.....Hold Open Stud | 25.00 | | | | 9140 Series - (ANCLR or ANDKB only) | | | |
| 5030-41.....Hold Open Nut | 6.00 | | | | 9140-3077.....Regular Arm | 120.00 | | |
| 5030-48.....Hold Open Forearm | 70.00 | | | | 9140-3077L.....Long Arm | 125.00 | | |
| 5030-49.....Hold Open Main Arm | 65.00 | 150.00 | | | 9140-72MC*.....Metal Cover | 185.00 | | |
| 5030-77.....Arm & Forearm | 120.00 | 260.00 | | | 9140-72FC*.....Full Metal Cover | 285.00 | | |
| 5030-79.....Rod & Shoe | 30.00 | 75.00 | | | 9140-MS-HDR.....Screw Pack Header | 25.00 | | |
| 5030-79H.....H Rod & Shoe | 30.00 | 75.00 | | | 9140-MS-PUSH.....Screw Pack Push Arm | 25.00 | | |
| 5030-83.....Arm Screw | 3.00 | | | | 9140-77.....Main Arm | 120.00 | | |
| 5030-83H.....H Arm Screw | 3.00 | | | | 9140-79.....Rod | 30.00 | | |
| 5030-159.....Arm Screw | 3.00 | | | | 9140-79LR.....Long Rod | 45.00 | | |
| 5030-416.....Wood Clip Set | 160.00 | 230.00 | | | 9140-163.....Cover Insert | 12.00 | | |
| 5030-417.....Wood Clip Set | 160.00 | 230.00 | | | 9140-163-1.....Cover End Cap Insert | 12.00 | | |
| 5030-3002.....Mounting/Finish Plate | 150.00 | 290.00 | | | 9140-334.....Cover End Cap | 40.00 | | |
| 5030-Flat Box.....Flat Box w/Label | 5.00 | | | | 9140-3018.....Mounting Bracket | 150.00 | | |
| 5030-Instruction Sheet.....Instruction Sheet | 3.00 | | | | 9140-3155.....Label Kit | 30.00 | | |
| 5030-Rebox Kit.....Box & Instruction Sheet | 5.00 | | | | 9140-3351-1.....Switch Bracket 29" | 68.00 | | |
| 6030 Series | | | | | | | | |
| 6031(2,3,4,5)-3071.....Std Cylinder Assy | 1,160.00 | 1,450.00 | | 1,570.00 | 9140-3351-2.....Switch Bracket 41" | 68.00 | | |
| 6031(2,3,4,5)-3971.....Cylinder Only | 1,000.00 | | | | 9140-3351-3.....Switch Bracket 51" | 68.00 | | |
| 6030-3077T.....Standard Arm | 120.00 | 340.00 | | 370.00 | 9140-3454.....Motor Gearbox Assembly | 1,898.00 | | |
| 6030-3038B.....Track w/Bumper | 80.00 | | | | 9140-3454S.....Motor Gearbox Assembly w/Switch | 1,898.00 | | |
| 6030-3038HB.....Track w/Hold Open & Bumper | 110.00 | | | | 9140-3462SC.....Standard Control Box | 1,305.00 | | |
| 6030-WMS.....Screw Pack (incl -3034) | 50.00 | 70.00 | | 85.00 | 9140-3498-2A.....A/C Power Cable - 29" | 40.00 | | |
| 6030-TORX.....Screw Pack (incl -3034) | 65.00 | 85.00 | | 100.00 | 9140-3498-2B.....A/C Power Cable - 42" | 40.00 | | |
| 6030-83.....Arm Screw | 3.00 | | | | 9140-3498-2C.....A/C Power Cable - 52" | 40.00 | | |
| 6030-157.....Snubber | 15.00 | | | | 9140-Rebox Kit.....Box & Instruction Sheet | 5.00 | | |
| 6030-159.....Arm Screw | 3.00 | | | | 9150 Series - (ANCLR or ANDKB only) | | | |
| 6030-169.....Bumper Assy | 20.00 | | | | 9150-3077.....Regular Arm | 120.00 | | |
| 6030-416.....Wood Clip Set | 160.00 | 230.00 | | | 9150-3077L.....Long Arm | 125.00 | | |
| 6030-425.....Roller Lock Screw | 5.00 | | | | 9150-72MC*.....Metal Cover | 285.00 | | |
| 6030-3002.....Mounting/Finish Plate | 200.00 | 220.00 | | | 9150-MS-HDR.....Screw Pack Header | 25.00 | | |
| 6030-3034.....Track Roller | 35.00 | | | | 9150-MS-PULL.....Screw Pack Pull Arm | 25.00 | | |
| 6030-3034H.....Hold Open Track Roller | 35.00 | | | | 9150-MS-PUSH.....Screw Pack Push Arm | 25.00 | | |
| 6030-3054.....Hold Open Clip | 30.00 | | | | 9150-77.....Main Arm | 120.00 | | |
| 6030-Flat Box.....Flat Box w/Label | 5.00 | | | | 9150-79.....Rod | 30.00 | | |
| 6030-Instruction Sheet.....Instruction Sheet | 3.00 | | | | 9150-79LR.....Long Rod | 45.00 | | |
| 6030-Rebox Kit.....Box & Instruction Sheet | 5.00 | | | | 9150-163.....Cover Insert | 12.00 | | |
| 9130 Series - (ANCLR or ANDKB only) | | | | | | | | |
| 9130-3077T.....Standard Arm | 120.00 | | | | 9150-163-1.....Cover End Cap Insert | 12.00 | | |
| 9130-3077PLCM.....Standard Arm w/Track | 262.00 | | | | 9150-334.....Cover End Cap | 40.00 | | |
| 9130-3038.....Track | 75.00 | | | | 9150-360.....24v SO Kit | 25.00 | | |
| 9130-72MC*.....Metal Cover | 185.00 | | | | 9150-3018.....Mounting Bracket | 150.00 | | |
| 9130-72FC*.....Full Metal Cover | 285.00 | | | | 9150-3155.....Label Kit | 30.00 | | |
| 9130-MS-HDR.....Screw Pack Header | 25.00 | | | | 9150-3351-1.....Switch Bracket 29" | 68.00 | | |
| 9130-MS-PULL.....Screw Pack Pull Arm | 25.00 | | | | 9150-3351-2.....Switch Bracket 41" | 68.00 | | |
| 9130-73.....Track End Cap | 10.00 | | | | 9150-3351-3.....Switch Bracket 51" | 68.00 | | |
| 9130-163.....Cover Insert | 12.00 | | | | 9150-3454.....Motor Gearbox Assembly | 1,898.00 | | |
| 9130-163-1.....Cover End Cap Insert | 12.00 | | | | 9150-3454S.....Motor Gearbox Assembly w/Switch | 1,898.00 | | |
| 9130-334.....Cover End Cap | 40.00 | | | | 9150-3462SC.....Standard Control Box | 1,305.00 | | |
| 9130-360.....24v SO Kit | 25.00 | | | | 9150-3498-2A.....A/C Power Cable | 40.00 | | |
| 9150 Series - (ANCLR or ANDKB only) | | | | | | | | |
| 9150-3077T.....Standard Arm 250.00 | | | | | | | | |

9530 Series continued on next page

PARTS & ACCESSORIES

PRICE LIST

| PARTS & ACCESSORIES | STANDARD POWDER COAT FINISHES ANCLR ANDKB | PLATED FINISHES | | PARTS & ACCESSORIES | STANDARD POWDER COAT FINISHES ANCLR ANDKB | PLATED FINISHES | |
|--|---|-----------------|--|--|---|-----------------|--|
| | | | | | | | |
| <i>9530 Series continued</i> | | | | | | | |
| 9530-3077PLCM..... Standard Arm w/Track | 362.00 | | | 9550-3572HL*..... Header Assy | 600.00 | | |
| 9530-3038..... Track | 75.00 | | | 9550-MS-HDR..... Screw Pack Header | 25.00 | | |
| 9530-3572HL*..... Header Assy | 350.00 | | | 9550-MS-PULL..... Screw Pack Pull Arm | 25.00 | | |
| 9530-3572DD*..... Double Door Header Assy | 600.00 | | | 9550-MS-PUSH..... Screw Pack Push Arm | 25.00 | | |
| 9530-MS-HDR..... Screw Pack Header | 25.00 | | | 9550-11A..... Spindle Plate - 2 3/4" | 80.00 | | |
| 9530-MS-PULL..... Screw Pack Pull Arm | 25.00 | | | 9550-11B..... Spindle Plate - 3 3/4" | 80.00 | | |
| 9530-11A..... Spindle Plate - 2 3/4" | 80.00 | | | 9550-12*..... Blank Filler Plate | 95.00 | | |
| 9530-11B..... Spindle Plate - 3 3/4" | 80.00 | | | 9550-18*..... Mounting Plate** | 80.00 / ft | | |
| 9530-12*..... Blank Filler Plate | 95.00 | | | **Add 3 1/2" if Using Angled Brackets | | | |
| 9530-18*..... Mounting Plate** | 80.00 / ft | | | 9550-77..... Main Arm | 200.00 | | |
| **Add 3 1/2" if Using Angled Brackets | | | | | | | |
| 9530-73..... Track End Cap | 10.00 | | | 9550-79..... Rod & Shoe | 60.00 | | |
| 9530-275..... Mounting Bracket - 2 3/4" | 105.00 | | | 9550-79LR..... Long Rod & Shoe | 60.00 | | |
| 9530-334..... Header Endcap | 45.00 | | | 9550-82..... Rod | 40.00 | | |
| 9530-334-1..... Angled Bracket | 167.00 | | | 9550-82L..... Long Rod | 40.00 | | |
| 9530-334-2..... End Dress Plate | 80.00 | | | 9550-275..... Mounting Bracket - 2 3/4" | 105.00 | | |
| 9530-375..... Mounting Bracket - 3 3/4" | 105.00 | | | 9550-334..... Header Endcap | 45.00 | | |
| 9530-511*..... Dress Plate Extrusion Only | 20.00 / ft | | | 9550-334-1..... Angled Bracket | 167.00 | | |
| 9530-518..... Cable/Parts Bag | 95.00 | | | 9550-334-2..... End Dress Plate | 80.00 | | |
| 9530-572*..... Header Extrusion Only | 57.00 / ft | | | 9550-375..... Mounting Bracket - 3 3/4" | 105.00 | | |
| 9530-572HL*..... Header Only | 228.00 | | | 9550-511..... Dress Plate Extrusion Only | 20.00 / ft | | |
| 9530-572DD*..... Double Door Header Only | 483.00 | | | 9550-518..... Cable/Parts Bag | 95.00 | | |
| 9530-3018..... Rear Mount Bracket | 105.00 | | | 9550-572*..... Header Extrusion Only | 57.00 / ft | | |
| 9530-3034..... Track Roller | 35.00 | | | 9550-572HL*..... Header Only | 456.00 | | |
| 9530-3155..... Label Kit | 30.00 | | | 9550-982..... Companion Cable | 70.00 | | |
| 9530-3454..... Motor Gearbox (Std Force) | 2,373.00 | | | 9550-3018..... Rear Mount Bracket | 105.00 | | |
| 9530-3462..... Controller | 1,543.00 | | | 9550-3034..... Track Roller | 35.00 | | |
| 9540 Series - (ANCLR or ANDKB only) | | | | | | | |
| 9540-3077..... Regular Arm | 240.00 | | | 9550-3155..... Label Kit | 30.00 | | |
| 9540-3077L..... Long Arm | 250.00 | | | 9550-3454..... Motor Gearbox (Std Force) | 2,373.00 | | |
| 9540-3572HL*..... Header Assy | 350.00 | | | 9550-3462..... Controller | 1,543.00 | | |
| 9540-3572DD*..... Double Door Header Assy | 600.00 | | | 9560 Series - (ANCLR or ANDKB only) | | | |
| 9540-MS-HDR..... Screw Pack Header | 25.00 | | | 9560-3077..... Regular Arm | 500.00 | | |
| 9540-MS-PUSH..... Screw Pack Push Arm | 25.00 | | | 9560-3077L..... Long Arm | 500.00 | | |
| 9540-11A..... Spindle Plate - 2 3/4" | 80.00 | | | 9560-3077T..... Standard Arm | 500.00 | | |
| 9540-11B..... Spindle Plate - 3 3/4" | 80.00 | | | 9560-3077PLCM..... Standard Arm w/Track | 362.00 | | |
| 9540-12*..... Blank Filler Plate | 95.00 | | | 9560-3038..... Track | 75.00 | | |
| 9540-18*..... Mounting Plate** | 80.00 / ft | | | 9560-3572HL*..... Header Assy | 570.00 | | |
| **Add 3 1/2" if Using Angled Brackets | | | | | | | |
| 9540-77..... Main Arm | 200.00 | | | 9560-MS-HDR..... Screw Pack Header | 25.00 | | |
| 9540-79..... Rod & Shoe | 60.00 | | | 9560-MS-PULL..... Screw Pack Pull Arm | 25.00 | | |
| 9540-79LR..... Long Rod | 60.00 | | | 9560-MS-PUSH..... Screw Pack Push Arm | 25.00 | | |
| 9540-82..... Rod | 40.00 | | | 9560-11A..... Spindle Plate - 2 3/4" | 75.00 | | |
| 9540-82L..... Long Rod | 40.00 | | | 9560-11B..... Spindle Plate - 3 3/4" | 75.00 | | |
| 9540-275..... Mounting Bracket - 2 3/4" | 105.00 | | | 9560-12*..... Blank Filler Plate | 95.00 | | |
| 9540-334..... Header Endcap | 45.00 | | | 9560-18*..... Mounting Plate** | 80.00 / ft | | |
| 9540-334-1..... Angled Bracket | 167.00 | | | **Add 3 1/2" if Using Angled Brackets | | | |
| 9540-334-2..... End Dress Plate | 80.00 | | | 9560-77..... Main Arm | 200.00 | | |
| 9540-375..... Mounting Bracket - 3 3/4" | 105.00 | | | 9560-79..... Rod & Shoe | 60.00 | | |
| 9540-511*..... Dress Plate Extrusion Only | 20.00 / ft | | | 9560-79LR..... Long Rod & Shoe | 60.00 | | |
| 9540-518..... Cable/Parts Bag | 95.00 | | | 9560-82..... Rod | 40.00 | | |
| 9540-572*..... Header Extrusion Only | 57.00 / ft | | | 9560-82L..... Long Rod | 40.00 | | |
| 9540-572HL*..... Header Only | 221.00 | | | 9560-275..... Mounting Bracket - 2 3/4" | 105.00 | | |
| 9540-572DD*..... Double Door Header Only | 483.00 | | | 9560-334..... Header Endcap | 45.00 | | |
| 9540-3018..... Rear Mount Bracket | 105.00 | | | 9560-334-1..... Angled Bracket | 167.00 | | |
| 9540-3155..... Label Kit | 30.00 | | | 9560-334-2..... End Dress Plate | 80.00 | | |
| 9540-3454..... Motor Gearbox (Std Force) | 2,373.00 | | | 9560-375..... Mounting Bracket - 3 3/4" | 105.00 | | |
| 9540-3462..... Controller | 1,543.00 | | | 9560-511*..... Dress Plate Extrusion Only | 20.00 / ft | | |
| 9550 Series - (ANCLR or ANDKB only) | | | | | | | |
| 9550-3077..... Regular Arm | 500.00 | | | 9560-518..... Cable/Parts Bag | 95.00 | | |
| 9550-3077L..... Long Arm | 500.00 | | | 9560-572*..... Header Extrusion Only | 57.00 / ft | | |
| 9550-3077T..... Standard Arm | 500.00 | | | 9560-572HL*..... Header Only | 546.00 | | |
| 9550-3077PLCM..... Standard Arm w/Track | 362.00 | | | 9560-3018..... Rear Mount Bracket | 105.00 | | |
| 9550-3038..... Track | 75.00 | | | 9560-3034..... Track Roller | 35.00 | | |
| 9560 Series - (ANCLR or ANDKB only) | | | | | | | |
| 9560-3077..... Regular Arm | 500.00 | | | 9560-3155..... Label Kit | 30.00 | | |
| 9560-3077L..... Long Arm | 500.00 | | | 9560-3454..... Motor Gearbox (Std Force) | 2,373.00 | | |
| 9560-3077T..... Standard Arm | 500.00 | | | 9560-3462..... Controller | 1,543.00 | | |
| 9560-3077PLCM..... Standard Arm w/Track | 362.00 | | | | | | |
| 9560-3038..... Track | 75.00 | | | | | | |
| 9560-3572HL*..... Header Assy | 570.00 | | | | | | |
| 9560-MS-HDR..... Screw Pack Header | 25.00 | | | | | | |
| 9560-MS-PULL..... Screw Pack Pull Arm | 25.00 | | | | | | |
| 9560-MS-PUSH..... Screw Pack Push Arm | 25.00 | | | | | | |
| 9560-11A..... Spindle Plate - 2 3/4" | 75.00 | | | | | | |
| 9560-11B..... Spindle Plate - 3 3/4" | 75.00 | | | | | | |
| 9560-12*..... Blank Filler Plate | 95.00 | | | | | | |
| 9560-18*..... Mounting Plate** | 80.00 / ft | | | | | | |
| **Add 3 1/2" if Using Angled Brackets | | | | | | | |
| 9560-77..... Main Arm | 200.00 | | | | | | |
| 9560-79..... Rod & Shoe | 60.00 | | | | | | |
| 9560-79LR..... Long Rod & Shoe | 60.00 | | | | | | |
| 9560-82..... Rod | 40.00 | | | | | | |
| 9560-82L..... Long Rod | 40.00 | | | | | | |
| 9560-275..... Mounting Bracket - 2 3/4" | 105.00 | | | | | | |
| 9560-334..... Header Endcap | 45.00 | | | | | | |
| 9560-334-1..... Angled Bracket | 167.00 | | | | | | |
| 9560-334-2..... End Dress Plate | 80.00 | | | | | | |
| 9560-375..... Mounting Bracket - 3 3/4" | 105.00 | | | | | | |
| 9560-511*..... Dress Plate Extrusion Only | 20.00 / ft | | | | | | |
| 9560-518..... Cable/Parts Bag | 95.00 | | | | | | |
| 9560-572*..... Header Extrusion Only | 57.00 / ft | | | | | | |
| 9560-572HL*..... Header Only | 546.00 | | | | | | |
| 9560-3018..... Rear Mount Bracket | 105.00 | | | | | | |
| 9560-3034..... Track Roller | 35.00 | | | | | | |
| 9560-3155..... Label Kit | 30.00 | | | | | | |
| 9560-3454..... Motor Gearbox (Std Force) | 2,373.00 | | | | | | |
| 9560-3462..... Controller | 1,543.00 | | | | | | |

Senior Swing® Basic Parts Diagram (2800 / 9500 Series)

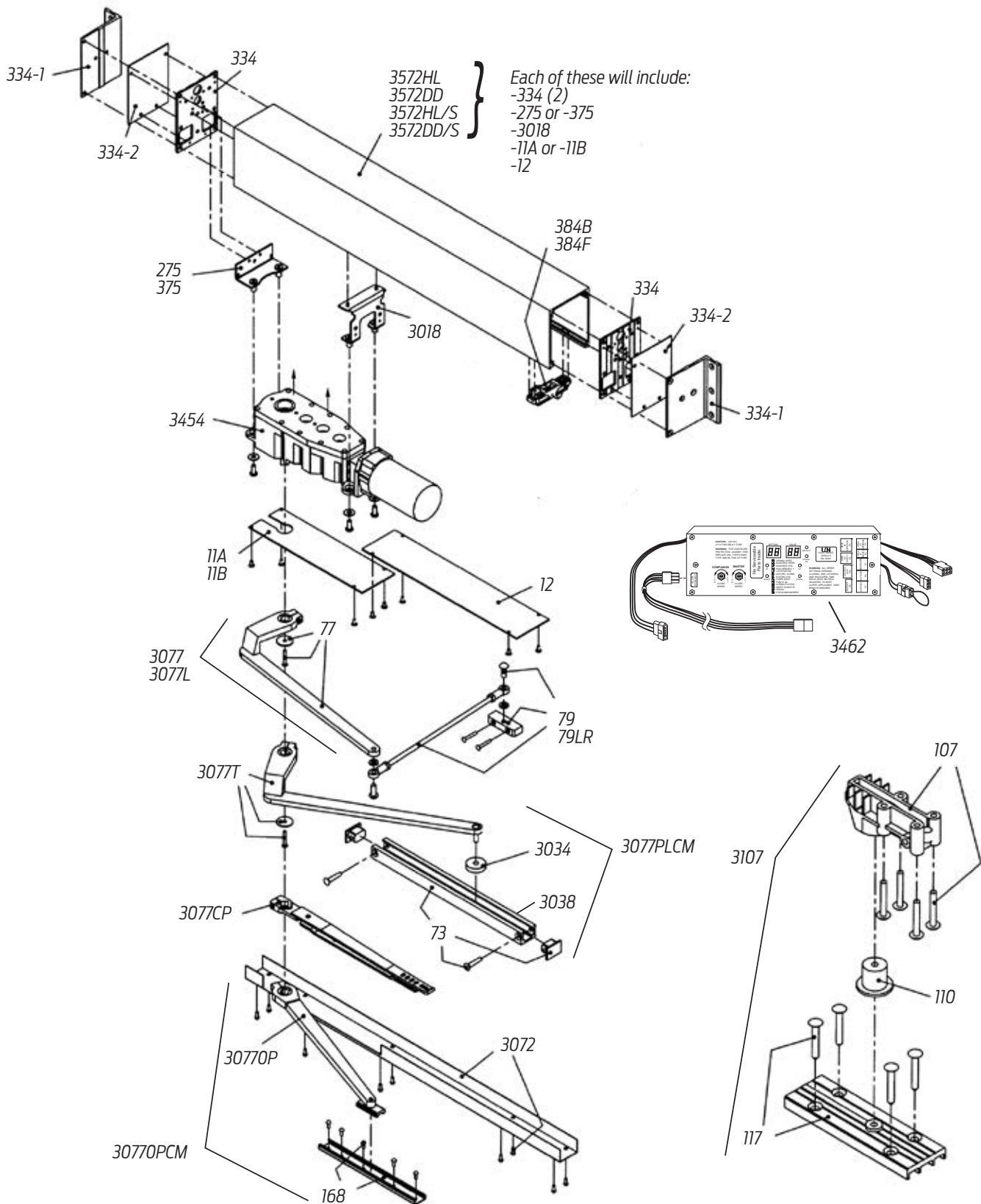

Benchmark Basic Parts Diagram

(9100 Series)

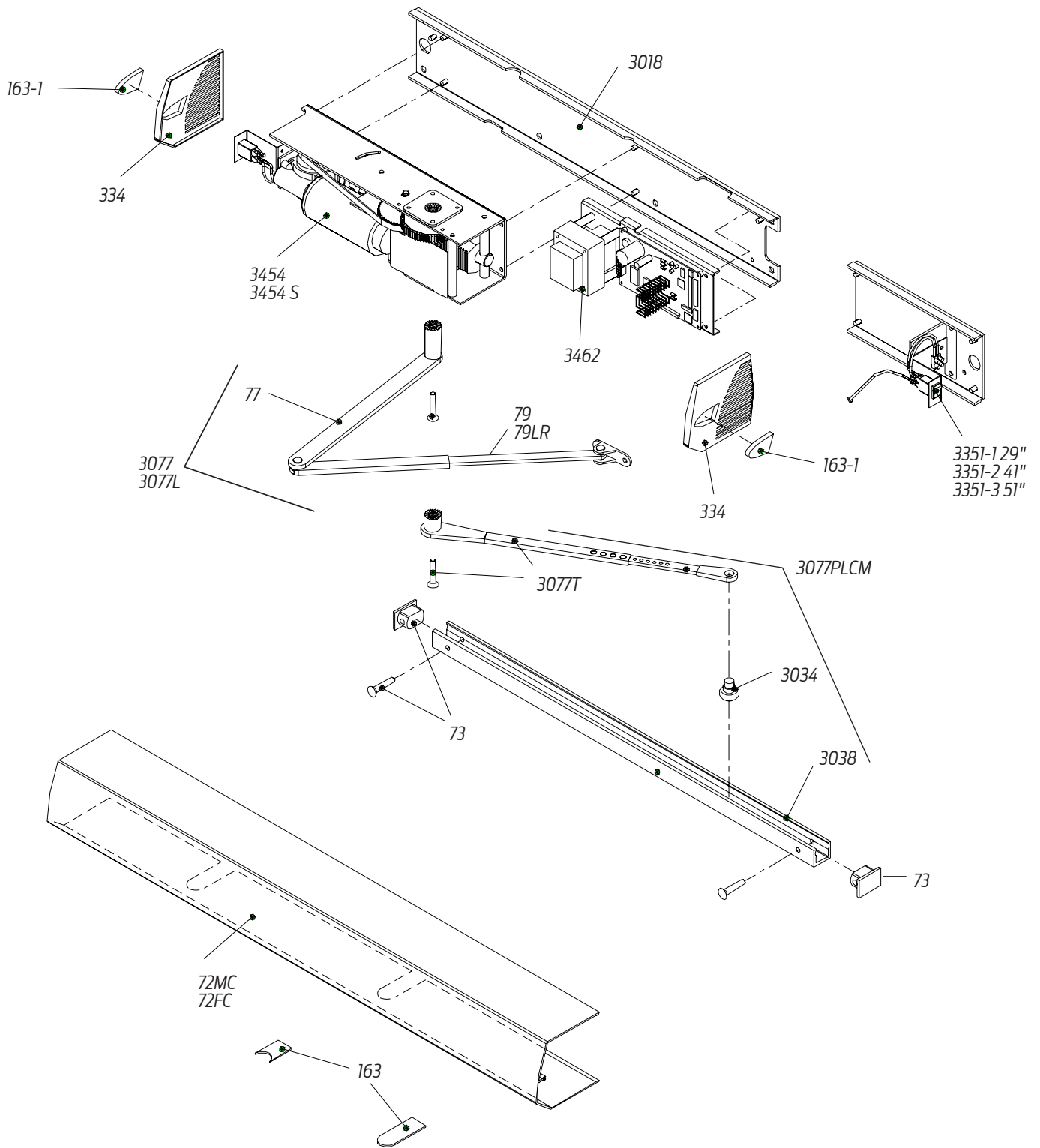

GLOSSARY OF ABBREVIATIONS

Arm Options

| | |
|----------------|--|
| STD | - Standard Arm |
| REG | - Regular Arm |
| Rw/PA | - Regular Arm w/ Parallel Arm Shoe |
| Rw/62A | - Regular Arm w/ Auxiliary Parallel Arm Shoe |
| H | - Hold Open Arm |
| Hw/PA | - Hold Open Arm w/ Parallel Arm Shoe |
| HD | - Heavy Duty Arm (1460) |
| HDw/PA | - Heavy Duty Arm w/ Parallel Arm Shoe |
| LD | - Light Duty Arm |
| LDw/PA | - Light Duty Arm w/ Parallel Arm Shoe |
| LONG | - Long Arm |
| XLONG | - Extra Long Arm |
| HLONG | - Hold Open Long Arm |
| EDA | - Extra Duty Arm |
| EDAw/62G | - Extra Duty Arm w/ Thick Hub Shoe |
| HEDA | - Hold Open Extra Duty Arm |
| HEDAw/62G | - Hold Open Extra Duty Arm w/ 62G |
| CUSH (CNS) | - Cush -n- Stop Arm |
| HCUSH (HCNS) | - Hold Open Cush -n- Stop Arm |
| SCUSH (SCNS) | - Spring Cush -n- Stop Arm |
| SHCUSH (SHCNS) | - Spring Hold Open Cush -n- Stop Arm |
| SF | - Swing Free Arm (4310ME) |
| DE | - Double Egress Arm |
| FL | - Fusible Link Arm |

Cylinder Options

| | |
|----------|---------------------------------------|
| STD | - Standard Cylinder |
| DEL (DA) | - Delay Action Cylinder |
| AVB | - Advanced Variable Backcheck |
| B80 | - Bypass 80 Degree ME Cylinder |
| B140 | - Bypass 140 Degree ME Cylinder |
| TEL | - Telephone Cylinder (4010/4020/4110) |

Cover Options

| | |
|----------|--------------------------------|
| STD | - Standard Plastic Cover |
| MC | - Metal Cover |
| FC | - Full Cover (1460) |
| DS (DS1) | - Designer Series Cover (1460) |

Track Options

| | |
|--------|-------------------------------|
| STD | - Standard Track |
| H | - Hold Open Track |
| BUMPER | - Track with Bumper |
| HBMP | - Hold Open Track with Bumper |

Fastener Pack Options

| | |
|-------|--|
| WMS | - Wood & Machine Screws |
| TBWMS | - Thru-Bolt, Wood & Machine Screws |
| SRT | - Self Reaming & Tapping Screws |
| TBSRT | - Thru-Bolt, Self Reaming & Tapping Screws |
| TORX | - TORX Machine Screws |
| TBTRX | - Thru-Bolt, TORX Machine Screws |

Finishes

| | |
|-------|--|
| AL | - Aluminum |
| DKBRZ | - Dark Bronze |
| BRASS | - Brass |
| LTBRZ | - Light Bronze |
| STAT | - Statuary |
| BLACK | - Black |
| MTLPC | - Bright Metallic |
| RAL | - Custom Finish Designation (RAL xxxx) |
| ANCLR | - Anodized Clear |
| ANDKB | - Anodized Dark Bronze |

Swing Operator Terms

| | |
|-----|--------------------------------|
| SF | - Standard Force Motor Gearbox |
| SC | - Standard Controller |
| POS | - Positive Mechanical Stop |
| BKY | - Breakaway Stop |

Miscellaneous Terms

| | |
|-------------|--|
| L | - Long |
| LR | - Long Rod |
| ELR | - Extra Long Rod |
| B80 or B140 | - Bypass (Fire/Life Safety) |
| SRI | - Special Rust Inhibitor |
| SE | - Single Point Electronic (Fire/Life Safety) |
| ME | - Multi-Point Electronic (Fire/Life Safety) |
| PAH | - Parallel Arm Holder (PAH60) |
| ES | - Electric Strike (Control Boxes) |
| S (SEQ) | - Sequential (Control Boxes) |
| TJ | - Top Jamb |
| PA | - Parallel Arm |
| 18G | - Flush Ceiling |
| T | - Track |
| DPS | - Door Position Switch (2210DPS) |
| FP | - Fire Protection Fluid |

Header Options

| Part | Extrusion (36" to 188") No Prep | Single Door* (36" to 49") Prepped | Door Pair (50" to 98") Prepped | Double Door Header** Prepped | Gearbox Brackets Included | Angle Brackets Included | End Caps Included | Filler Plates Included | Stop Prep*** Included |
|-----------|---------------------------------------|---|--------------------------------------|------------------------------------|---------------------------------|-------------------------------|----------------------|------------------------------|--------------------------|
| -572 | X | | | | | | | | |
| -572HL | | X | X | | | | | | |
| -572HL/S | | X | X | | | | | | X |
| -572DD | | | | X | | | | | |
| -572DD/S | | | | X | | | | | X |
| -3572HL | | X | X | | X | X | X | X | |
| -3572HL/S | | X | X | | X | X | X | X | X |
| -3572DD | | | | X | X | X | X | X | |
| -3572DD/S | | | | X | X | X | X | X | X |

*2810, 9530 or 9540 only

**2850, 2860, 9550 or 9560 only

*** 2810, 2850 or 2860 only

A library of common wiring diagrams are available at no-charge for use in single and double door applications utilizing various configurations of Allegion door hardware products. These diagrams and much more can be accessed through our Knowledge Center tool at <http://kc.allegion.com/>, simply click on the link Common wiring diagrams.

Custom Wiring Diagrams

When common wiring diagrams do not meet the needs of the job requirements, Allegion offers a service to purchase custom wiring diagrams. All custom wiring diagrams include a point-to-point drawing, a riser diagram, and a detailed theory of operation. Custom wiring diagrams fall into two categories; Standard and Complex.

- Standard drawings: All Allegion products with a single opening and a basic theory of operation. These drawings will be quoted a NET \$250 for each drawing
- Complex drawings: Generic contacts, 3rd party components, complex relay logic, timer circuit logic, any other additional advanced logic. Drawings that fall under this type will receive a NET quote depending on the time required to complete the drawings at an hourly rate of \$200/hour with a \$250 minimum NET

How to Request a Quote for a Custom Wiring Diagram

- Custom wiring diagrams can only be ordered by and shipped to current Allegion Channel Partners
- Wiring Diagram Request Forms can be obtained by:
 - Sending an email request to Wiring.Diagram.Request@allegion.com
 - Using the online Distributor Portal under; My Support / Orders & Invoicing
 - Using the form located on the following page
- Once completed, email the completed request form to Wiring.Diagram.Request@allegion.com for processing
 - Be sure and include the following information to prevent delays to the request:
 - All supporting documentation for non-Allegion products
 - Hardware list with complete part numbers
 - Detailed Theory of operation for all openings
- Upon receipt the custom wiring coordinator will review and clarify the request as needed
- Once all clarifications are resolved a QUOTE#, NET pricing, and lead time will be assigned and communicated to the requestor within 1 business day
- QUOTE# is valid for 90 days
- A purchase order with the QUOTE# must be received for the wiring diagrams to be produced
 - Send the completed PO to Wiring.Diagram.Request@allegion.com
- Lead time is generally 2-3 weeks from time PO is received, more complex requests will have longer lead times
- Changes to the original request after a quote approval may incur additional charges and affect lead time
- Completed custom wiring diagrams will be emailed to the requestor

Notes

Wiring Diagram Request Form



ALLEGION™

Must be a Schlage Electronics, LCN, or Von Duprin Dealer

=====
Date ___/___/___ Project Name _____

Dealer/Distributor _____

Account # _____ Dealer Contact Name _____ Phone ____-____-____

=====
Provide a Primary Technical Contact _____ Phone ____-____-____
=====

Provide/Attach the Following

- All supporting documentation for all non-Allegion products.
 - Included hardware list with complete part numbers.
 - Detailed Theory of Operation for all openings.

Additional information that helps expedite the project:

Door Number; Door Size; Door Material;
Fire Rated Opening; Single/Pair; Double Egress; Interior/Exterior;
Interlocked Opening; Basic Floor Plan/Traffic Flow

=====
E-mail completed form and supporting documentation to

Wiring.Diagram.Request@allegion.com

Phone: 877-671-7011

LCN Limited Warranty

Subject to the terms and conditions of this limited warranty, Schlage Lock Company, LLC (the "Company") extends a limited warranty against defects in material and workmanship for its LCN branded product(s) identified in the Product Table below ("Products") as installed in the original location.

This limited warranty applies to Products purchased on or after **March 3, 2014**.

Product Table

| | |
|--|----------|
| 4000 Series | 30 Years |
| 4050 Series | 25 Years |
| 1460 Series | 30 Years |
| 1450 Series | 25 Years |
| 1260 Series | 20 Years |
| 1250 Series | 15 Years |
| Concealed, High Security (except 2210DPS) | 15 Years |
| Automatic Operators; SE, ME, HSA, SEH Series; SEM Magnets; 2210 DPS (includes both electronic and mechanical components) | 2 Years |

Term: The limited warranty period for Products is as stated in the Product Table above. The "Commencement Date" for a limited warranty period shall be the date of Company's delivery to the original purchaser of the Products. Proof of Product purchase may be required by Company to confirm the Commencement Date.

What Company will do: Company may require proof of Product purchase in order to provide coverage under this limited warranty. As Company's only responsibility and user's only remedy under this limited warranty, Company will furnish a replacement Product upon receipt and confirmation by Company, in its sole opinion, that the Product has, in fact, failed due to a manufacturing defect under normal use and maintenance. In the event a replacement Product cannot be provided, Company will either provide a suitable replacement Product or a refund in the amount of the original purchase price.

What is not covered: The following costs, expenses, and damages are not covered by the provisions of this limited warranty: (i) labor costs including, but not limited to, such costs as removal and installation of Product; (ii) shipping and freight expenses required to return Product to Company; (iii) failures, defects, or damage caused by any third party product or service; (iv) any other incidental, consequential, indirect, special and/or punitive damages, whether based on contract, warranty, tort (including, but not limited to, strict liability or negligence), patent infringement, or otherwise, even if advised of the possibility of such damages.

The provisions of this limited warranty do not apply to Product that is: (i) not the proper size for the application for which the Product is used; (ii) not installed in accordance with Company's published Product installation instructions; (iii) installed with improper parts and/or incorrect parts (NOTE: It is recommended that Product be installed with LCN fasteners provided with Product); (iv) improperly stored, maintained, or operated; (v) modified, repaired, or altered in Company's sole opinion, in any manner, without the express written consent of Company; (vi) used for purposes for which the Product is not designed or intended; (vii) subjected to misuse, abuse, negligence, or accident; or (viii) subjected to improper temperature, humidity, or other environmental conditions.

Note: 900/7900 Series compressors are not manufactured by Company and are excluded from coverage under this limited warranty. For more information, parts, or repairs concerning the compressors, contact the compressor manufacturer directly at (269) 926-6171.

Additional Terms: This limited warranty is in lieu of all other warranties, express or implied. Company does not authorize any person to create for it any obligation or liability in connection with Product. Company's maximum liability hereunder is limited to the original purchase price of the Product. No action arising out any claimed breach of this limited warranty by Company may be brought by the user more than one (1) year after the cause of action has arisen.

How local law applies: This limited warranty gives you specific legal rights, and you may also have other rights as permitted by law. Some local laws do not allow limitations on how long an implied warranty lasts or the exclusions or limitation of incidental or consequential damages so the limitations or exclusions provided herein may not apply to you.

Program and Warranty Claims: If Product is to be claimed to be defective under this limited warranty, contact Customer Care at (877) 671-7011.

Note: Please contact LCN Customer Care prior to returning any product back to the factory. You will need prior authorization and an RMA for your return.

About Allegion

Allegion (NYSE: ALLE) creates peace of mind by pioneering safety and security. As a \$2 billion provider of security solutions for homes and businesses, Allegion employs more than 8,000 people and sells products in more than 120 countries across the world. Allegion comprises 27 global brands, including strategic brands CISA®, Interflex®, LCN®, Schlage® and Von Duprin®.

For more, visit www.allegion.com

KRYPTONITE ■ LCN ■  ■ STEELCRAFT ■ VON DUPRIN